



inducción

bobinas de inducción



1

código	404010	referencia	AD100087
descripción	bobina de inducción ø 220mm H 10mm		
Para modelos:	GIC3035		

resistencias

resistencias para hornos

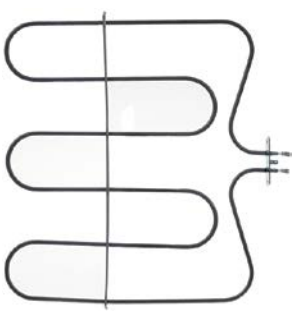

1

código	416969	referencia	01203250
descripción	resistencia 1400W 230V espirales 1 L 370mm An 400mm L1 45mm L2 325mm B1 184mm B2 30mm longitud brida 70mm anchura brida 22mm dist. del agujero 46mm longitud distancial 420mm agujero ø 5mm tubo ø 6.3mm empalme conector Faston 6,3mm espirales 3 brida rectangular resistencia seca		
Para modelos:	GCO2001		
accesorios para	416969		
	código	510368	referencia —
	junta L 70mm An 23.5mm agujero ø 5mm dist. del agujero 56mm FIBER espesor 2mm para resistencia		

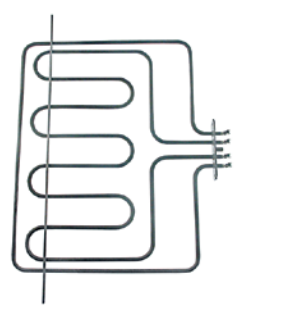

1

código	416970	referencia	01203240
descripción	resistencia 2800W 230V espirales 2 L 323mm An 393mm L1 30mm L2 293mm B1 166mm B2 61mm longitud brida 100mm anchura brida 22mm dist. del agujero 76mm longitud distancial 485mm agujero ø 5mm tubo ø 6.3mm empalme conector Faston 6,3mm brida rectangular resistencia seca		
Para modelos:	GCO2001		
accesorios para	416970		
	código	528090	referencia 01000160
	junta L 100mm An 22mm espesor 1mm		

resistencias para freidora

sujeción 2 orificios

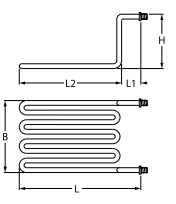
1

código	417598	referencia	1.07.HDF4140403
descripción	resistencia 2500W 230V espirales 1 L 290mm An 130mm H 200mm L1 40mm L2 230mm tubo ø 8mm		
Para modelos:	GDF3004, GDF3024		

1

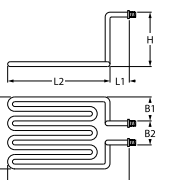
código	417599	referencia	1.07.HDF8141903
descripción	resistencia 3250W 230V espirales 1 rosca M12x1,25 L 280mm An 190mm H 210mm L1 35mm L2 245mm B1 120mm B2 70mm tubo ø 8mm empalme M4		
Para modelos:	GDF3008, GDF3028, GDF5008, GDF5028		

resistencias para plancha grills



1

código	419177	referencia	D02169
descripción	resistencia 1750W 230V espirales 1 L 255mm An 240mm H 60mm tubo ø 6.3mm longitud del cable 600mm baño maría distancia de empalme 234mm resistencia seca		
Para modelos:	GEG2001		



resistencias para máquinas hot-dog

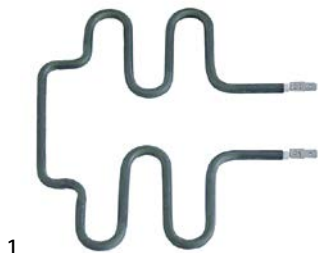

1

código	416718	referencia	D02002
descripción	resistencia 300W 230V L 170mm An 198mm tubo \varnothing 6.3mm L1 50mm L2 120mm B1 68mm B2 62mm empalme conector Faston 6,3mm distancia de empalme 56mm resistencia seca espirales 1 grill para hot dog		
Para modelos:	GHM1001		

cables de calefacción

otros



1

código	417745	referencia	W0310067
descripción	cable de calefacción 600V L 1100mm silicona empalme conector GFR2700		
Para modelos:	GFR2700		

resistencias de cuarzo



1

código	420089	referencia	D04034	
descripción	resistencia de cuarzo 600W 115V L 365mm \varnothing 11mm empalme conector Faston 6,3mm			
Para modelos:	GTO1001, GTO2001			
accesorios para	420089			
	código	551108	referencia	B07025
	resorte de fijación acero inoxidable para resistencia de cuarzo L 39mm An 25mm H 13.5mm taladro \varnothing 10mm			



1

código	551108	referencia	B07025
descripción	resorte de fijación acero inoxidable para resistencia de cuarzo L 39mm An 25mm H 13.5mm taladro \varnothing 10mm		
Para modelos:	GTO1001, GTO2001		



RESISTENCIAS MAKRO-PROFESSIONAL

resistencias de inmersión

brida 3 orificios \varnothing 38,5mm

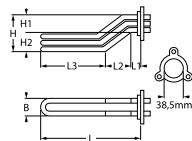
1



código	416267	referencia	905560	
descripción	resistencia 4500W 230V montaje \varnothing 38.5mm espirales 3 L 358mm An 32mm H 58mm L1 36mm L2 72mm L3 250mm H1 28mm H2 30mm dist. del agujero 57mm agujero \varnothing 10mm tubo \varnothing 6.3mm empalme conector Faston 6,3mm resistencia de inmersión brida 3 orificios			
Para modelos:	GDW2001			
repuestos para	416267			
	código	521120	referencia	907981
	junta tórica EPDM espesor 5.34mm int. \varnothing 37.47mm UE 1 pzs			
accesorios para	416267			
	código	532577	referencia	—
	junta tórica EPDM espesor 5.34mm int. \varnothing 40.65mm UE 1 pzs			



1

código	416260	referencia	905745	
descripción	resistencia 2500W 230V espirales 1 L 357mm An 34mm H 39mm H1 4mm H2 35mm rosca M10x1 distancia de sujeción 28mm tubo \varnothing 6.3mm empalme conector Faston 6,3mm sujeción 2 orificios resistencia de inmersión longitud de empalme 25mm			
Para modelos:	GDW2001			
accesorios para	416260			
	código	510416	referencia	—
	junta plana fibra \varnothing ext. 19mm int. \varnothing 10.5mm espesor 1.5mm para rosca M10 UE 1 pzs			
	código	510893	referencia	—
	junta tórica EPDM espesor 2.62mm int. \varnothing 9.92mm UE 1 pzs			
	código	520231	referencia	—
	tuerca rosca M10x1 H 6mm EC 14 acero zincado UE 1 pzs			
	código	521129	referencia	—
	tuerca rosca M10 H 6mm inox EC 17 UE 1 pzs DIN/ISO DIN 439			



resistencias circulación de aire



1

código	418044	referencia	01203260
descripción	resistencia 2500W 230V espirales 1 int.ø 180mm ø ext. 192mm L 245mm H 28mm L1 45mm B1 30mm H1 3mm H2 25mm longitud brida 70mm anchura brida 22mm dist. del agujero 56mm empalme conector Faston 6,3mm tubo ø 6.3mm resistencia circulación de aire agujero ø 5mm brida rectangular		
Para modelos:	GCO2001		
accesorios para	418044		
	código	550937	referencia 01000140
	junta L 71mm An 21mm agujero ø 5mm dist. del agujero 57mm fibra espesor 1mm para resistencia		



1

código	419243	referencia	RES30033
descripción	resistencia 2700W 230V espirales 1 int.ø 180mm ø ext. 193mm L 208mm H 30mm L1 8mm B1 30mm H1 7mm H2 23mm anchura brida 22mm dist. del agujero 56mm empalme conector Faston 6,3mm tubo ø 6.3mm resistencia circulación de aire agujero ø 5mm brida rectangular 70 x 22 mm con tornillos		
Para modelos:	GCO500		
repuestos para	419243		
	código	560102	referencia —
	tornillos de chapa ø 3.9mm L 9.5mm inox UE 20 pzs DIN 7981/ISO 7049 ø cabezal 7.5mm cabeza gota de sebo		

resistencias planas



1

código	419256	referencia	W0310080
descripción	resistencia plana L 520mm An 220mm 61W 220V longitud del cable 400mm empalme conector GFR2700		
Para modelos:	GFR2700		

accesorios

diversos



1

código	551108	referencia	B07025
descripción	resorte de fijación acero inoxidable para resistencia de cuarzo L 39mm An 25mm H 13.5mm taladro ø 10mm		
Para modelos:	GTO1001, GTO2001		

anillos de junta

juntas tóricas

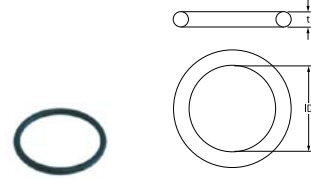

1

código	521120	referencia	907981
descripción	junta tórica EPDM espesor 5.34mm int.ø 37.47mm UE 1 pzs		
Para modelos:	GDW2001		

juntas para bridas



1

código	528090	referencia	01000160
descripción	junta L 100mm An 22mm espesor 1mm		
Para modelos:	GCO2001		



1

código	550937	referencia	01000140
descripción	junta L 71mm An 21mm agujero ø 5mm dist. del agujero 57mm fibra espesor 1mm para resistencia		
Para modelos:	GCO2001		

termostatos

termostatos de superficie

termostatos de superficie de seguridad



1

código	390717	referencia	907297
descripción	termómetro de superficie de seguridad dist. del agujero 23.8mm temp. desconexión 110°C 1NC 1 polos 16A 250V empalme F6,3 sujeción 2 orificios montaje ø 18.3mm		
Para modelos:	GDW2001		



termostatos de superficie



código	390869	referencia	253099000143
descripción	termostato de contacto dist. del agujero 23.5mm temp. desconexión 140°C 1NC 1 polos 10A 250V empalme F4,8 UE 1 pzs		
Para modelos:	GMW1025		



código	390634	referencia	TER30002
descripción	termostato de contacto dist. del agujero 23.5mm temp. desconexión 145°C 1NC 1 polos 16A 250V empalme F6,3 sujeción 2 orificios		
Para modelos:	GCO500		



código	390867	referencia	253099000224
descripción	termostato de contacto dist. del agujero 23.5mm temp. desconexión 180°C 1NC 1 polos 10A 250V empalme F4,8 UE 1 pzs		
Para modelos:	GMW1025		



código	390763	referencia	907244
descripción	termostato de contacto dist. del agujero 23.8mm temp. desconexión 55°C 1NC 1 polos 16A 250V empalme F6,3 sujeción 2 orificios para cuba		
Para modelos:	GDW2001		

termostatos de control y seguridad

EGO

termostatos de regulación

serie 55.17_



código	371320	referencia	A06032
descripción	termóstato T máx 280°C margen de trabajo 30-280°C 1 polos 1NO 16A sonda ø 3mm sonda L 170mm capilar 860mm aislamiento del capilarmm prensaestopas eje L 14mm posición del eje arriba ángulo de rotación 270°		
Para modelos:	GEG2001		



código	391048	referencia	TER30016
descripción	termóstato T máx 292°C 1 polos 1NO sonda ø 3mm sonda L 182mm eje ø 6x4,6mm eje L 23mm posición del eje arriba° ángulo de rotación 270° material de bulbo inox con accesorios montaje		
Para modelos:	GCO500		

termostatos de seguridad

serie 55.32_



código	390999	referencia	01202690
descripción	termostato de seguridad temp. desconexión 350°C margen de trabajo°C 2 polos NC 20A sonda ø 3mm sonda L 187mm capilar 690mm aislamiento del capilar 680mm prensaestopas eje ømm bulbo inox		
Para modelos:	GCO2001		

IMIT / TEMPOMATIC / ARTHERMO

termostatos de regulación

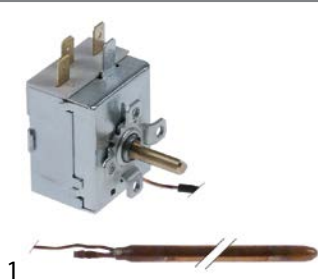

código	390683	referencia	TR0440
descripción	termóstato T máx 86°C margen de trabajo 0-86°C 1 polos 1CO 16A sonda ø 6.5mm sonda L 98mm capilar 1000mm aislamiento del capilar 960mm prensaestopas eje ø 6x4,6mm eje L 20mm posición del eje +135° ángulo de rotación 270° material de bulbo cobre		
Para modelos:	GDW2001		
accesorios para	390683		
	código	110100	referencia 903982
	pomo termostato T máx 90°C 0-90°C ø 42mm eje ø 6x4,6mm parte plana -135° negro		

TECASA

termostatos de regulación

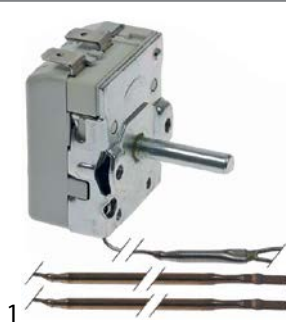

código	376091	referencia	01201220
descripción	termóstato T máx 328°C margen de trabajo 57-328°C 1 polos 1NO 16A sonda ø 3mm sonda L 98mm capilar 1540mm aislamiento del capilar 1500mm prensaestopas eje ø 6x4,6mm eje L 21mm ángulo de rotación 270° interruptor auxiliar rosca sonda ø arandelamm		
Para modelos:	GCO2001		

diversos

termostatos de regulación



código	390871	referencia	1.1.A.A06.02
descripción	termóstato T máx 95°C margen de trabajo 0-95°C 1 polos 1NO 6A sonda ø 6mm sonda L 95mm capilar 550mm aislamiento del capilar 490mm prensaestopas eje ø 6x4mm eje L 23mm posición del eje 45° ángulo de rotación 270° material de bulbo acero zincado 250V contactos conector Faston 4,8mm UE 1 pzs		
Para modelos:	GGC1078, GGC1078B		



código	390968	referencia	1.06.1851713
descripción	termostato de control T máx 185°C margen de trabajo 2 polos 1NO 16A sonda ø 6mm sonda L 77mm capilar 1500mm aislamiento del capilar 1500mm prensaestopas eje ø 6x4,6mm eje L 25mm posición del eje arriba ángulo de rotación 270° material de bulbo inox		
Para modelos:	GDF3004, GDF3008, GDF3024, GDF3028, GDF5008, GDF5028		

termostatos de seguridad



código	390970	referencia	1.06.230171301
descripción	termostato de seguridad temp. desconexión 230°C 2 polos 1NC 16A sonda ø 5mm sonda L 48mm capilar 440mm aislamiento del capilar 1500mm prensaestopas bulbo 250V modelo WQS-230		
Para modelos:	GDF3004, GDF3008, GDF3024, GDF3028, GDF5008, GDF5028		

termostatos para frío

universal con alojamiento



código	698867	referencia	GPC1046-09
descripción	termóstato bulbo capilar 650mm 1NO roscada tipo WPF17C-L2		
Para modelos:	GPC1046		



interruptores y pulsadores

interruptores/pulsadores basculantes

30x22mm



código	347791	referencia	1.1.A.A07.10 205426 A07034 E2301GR00001 S900.01 W0308019
descripción	interruptor basculante medida de montaje 30x22mm verde 2NO 230V 20A iluminado 0-I empalme conector Faston 6,3mm temperatura ambiente máx. 125/55°C protección IP65 con protección en goma		
Para modelos:	GCV1600, GDS2600, GFR2700, GHM1001, GHS1600, GHS2600, GJU1001, GPS2600, GRE2700, GSA2600, GSD2600, GSF2600		

ø20mm



código	347803	referencia	DQKA0000
descripción	interruptor basculante medida de montaje 20mm rojo 1NO 250V 15A 0-I empalme conector Faston 4,8mm temperatura ambiente máx. 85°C protección IP40		
Para modelos:	GSC1100G, GSC2336		

interruptores pulsantes y pulsadores

30x22mm



código	345712	referencia	00000700296
descripción	interruptor pulsante medida de montaje 30x22mm rojo/verde 2CO 250V 16A Stop / I empalme conector Faston 6,3mm temperatura ambiente máx. 85°C protección IP40 con indicador		
Para modelos:	GFS1022, GFS1025, GFS1030, GFS2019, GFS2022, GFS2025, GFS2030		
accesorios para	345712		
	código	301127	referencia 00000000285
	cubierta protectora dimensión interior 30x55mm transparente		

ø22mm



código	301127	referencia	00000000285
descripción	cubierta protectora dimensión interior 30x55mm transparente		
Para modelos:	GFS1022, GFS1025, GFS1030, GFS2019, GFS2025, GFS2030		

accesorios

teclas

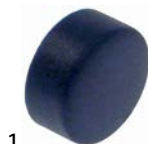

código	348239	referencia	905346
descripción	tecla para lavavajillas eje 3,7x3,7mm azul ø ext. 21mm int.ø 19mm		
Para modelos:	GDW2001		

portaelementos



código	348240	referencia	905341
descripción	portaelementos ø 23.5mm int.ø 21.5mm plata		
Para modelos:	GDW2001		

microinterruptores

accionados por pistón



código	347799	referencia	253039000003
descripción	microinterruptor con varilla 250V 15A 1CO empalme conector Faston 4,8mm temperatura ambiente máx. 105°C distancia de sujeción 22mm tipo W-15-102C fuerza de accionamiento: 180g blanco		
Para modelos:	GMW1025		



otros



1

código	347560	referencia	00000000304
descripción	microinterruptor con varilla distancia de sujeción 22mm rosca M10 rosca L 14mm 250V 12A 1NO empalme conector Faston 6,3mm carra 3.5mm temperatura ambiente máx. 125°C tipo VRSR03AA1 fuerza de accionamiento: 135g		
Para modelos:	GFS1025		

con tecla

interruptores de enganche rápido



1

código	348227	referencia	W0308012
descripción	microinterruptor 250V 0.5A empalme conector Faston 2,8mm para frigorífico GFR2700/GRE2700		
Para modelos:	GFR2700, GRE2700		



1

código	348192	referencia	I0202070
descripción	microinterruptor con tecla 250VA 1NO empalme conector Faston 6,3mm L 26x12mm temperatura ambiente máx. 85°C fuerza de accionamiento: 500g		
Para modelos:	GRE3600, GRE3600S		

interruptores posicionales

METRO



1

código	348088	referencia	1.05.035011HDFMS116
descripción	microinterruptor 1NO 250V 16A L 41mm An 12mm H 44mm fuerza de accionamiento: 250g		
Para modelos:	GDF3004, GDF3008, GDF3024, GDF3028, GDF5008, GDF5028		

interruptores de sistema ROLD



1

código	345651	referencia	905314
descripción	elemento de conmutación 2CO 250V 16A empalme conector Faston 6,3mm		
Para modelos:	GDW2001		



1

código	348238	referencia	905447
descripción	elemento de conmutación 2NO 250V 16A empalme conector Faston 6,3mm tipo SA		
Para modelos:	GDW2001		

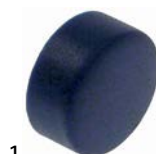

1

código	348239	referencia	905346
descripción	tecla para lavavajillas eje 3,7x3,7mm azul ø ext. 21mm int.ø 19mm		
Para modelos:	GDW2001		



1

código	301104	referencia	905312
descripción	unidad de pulsador 1NO 250V 16A empalme conector Faston 6,3mm		
Para modelos:	GDW2001		



comutadores de levas

4 posiciones

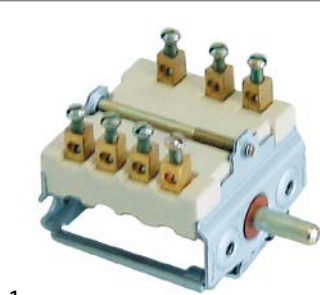

código	300094	referencia	A01001
descripción	comutador de levas 4 posiciones de control 1NO/2CO secuencia de conmutación 0-1-2-3 16A eje \varnothing 6x4,6mm eje L 15mm empalme atornillado 4 posiciones cerámica		
Para modelos:	GEG2001		

4 posiciones de conmutación



código	347101	referencia	A01017
descripción	comutador de levas 4 posiciones de control 1NO/1CO secuencia de conmutación 0-1-2-3 13A eje \varnothing 6x4,6mm eje L 23mm empalme conector Faston 6,3mm plástico		
Para modelos:	GTO1001, GTO2001		

10 posiciones de conmutación



código	301205	referencia	01200040
descripción	comutador de levas 10 posiciones de conmutación 5NO/1CO secuencia de conmutación 0-1-2-3-4-5-6-7-8-9 16A eje \varnothing 6x4,6mm eje L 23mm empalme conector Faston 6,3mm cerámica		
Para modelos:	GCO2001		

interruptores magnéticos

37x16mm

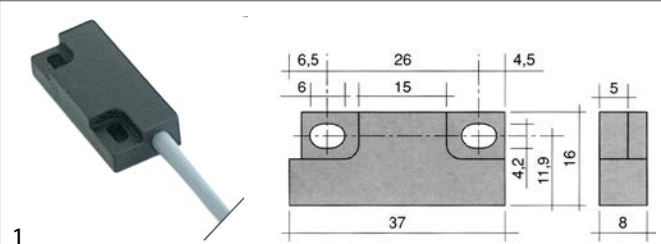

código	345341	referencia	909290
descripción	interruptor magnético L 37mm An 16mm 1NO 250V 0.04A P máx. 10W empalme cable longitud del cable 1960mm		
Para modelos:	GDW2001		

accesorios

imanes

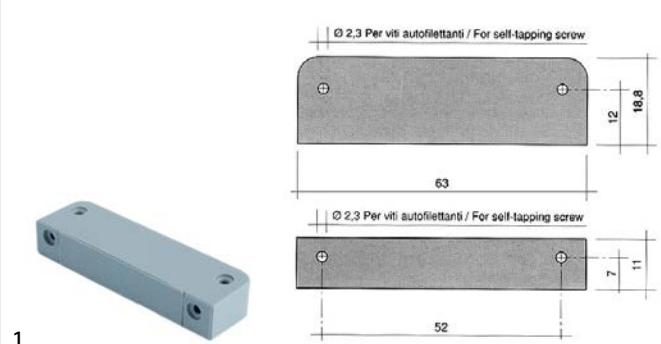

código	519049	referencia	903651
descripción	imán \varnothing mm L 63mm H 10.7mm An 18.8mm dist. del agujero 52mm M2 agujero \varnothing 2mm		
Para modelos:	GDW2001		

accesorios para	519049	código	560095	referencia	—
			tornillos de chapa \varnothing 2.9mm L 9.5mm inox UE 20 pzs DIN 7981/ISO 7049 \varnothing cabezal 5.6mm cabeza gota de sebo		

lámparas

lámparas de señalización

lámparas de señalización 2 piezas (lente y elemento)

casquillos para lámparas de señalización



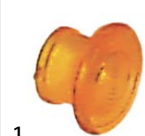

\varnothing 8mm (tipo RL-2)





código	359820	referencia	00002350
descripción	casquillo para lámpara de señalización amarillo UE 1 pzs \varnothing 8mm		
Para modelos:	GCO2001		





 <p>1</p>			
código	359819	referencia	00002360
descripción	casquillo para lámpara de señalización verde UE 1 pzs ø 8mm		
Para modelos:	GCO2001		

elementos de señalización para tipo de casquillo RL			
 <p>1</p>			
código	359818	referencia	01200330 IND30009
descripción	lámpara de señalización 230V claro empalme conector Faston 6,3mm		
Para modelos:	GCO2001, GCO500		
accesorios para	359818		
 <p>código 359820 referencia 00002350</p> <p>casquillo para lámpara de señalización amarillo UE 1 pzs ø 8mm</p>			
 <p>código 359833 referencia —</p> <p>casquillo para lámpara de señalización rojo UE 1 pzs ø 8mm</p>			
 <p>código 359948 referencia —</p> <p>casquillo para lámpara de señalización claro UE 1 pzs ø 8mm</p>			

 <p>1</p>			
código	359817	referencia	01200340
descripción	lámpara de señalización 230V verde empalme conector Faston 6,3mm		
Para modelos:	GCO2001		
accesorios para	359817		
 <p>código 359819 referencia 00002360</p> <p>casquillo para lámpara de señalización verde UE 1 pzs ø 8mm</p>			

lámparas de señalización completas			
ø 6mm			
 <p>1</p>			
código	359005	referencia	903644
descripción	lámpara de señalización ø 6mm 230V amarillo longitud del cable 400mm		
Para modelos:	GDW2001		

ø 9mm			
 <p>1</p>			
código	360765	referencia	903686
descripción	lámpara de señalización ø 8.5mm amarillo 250V empalme conector Faston 6,3mm longitud del cable 260/400mm resis.a la temp. 90°C		
Para modelos:	GDW2001		

 <p>1</p>			
código	360767	referencia	903685
descripción	lámpara de señalización ø 8.5mm amarillo 250V empalme conector Faston 6,3mm longitud del cable 260mm resis.a la temp. 120°C		
Para modelos:	GDW2001		

 <p>1</p>			
código	360766	referencia	903688
descripción	lámpara de señalización ø 8.5mm verde 250V empalme conector Faston 6,3mm longitud del cable 270mm resis.a la temp. 120°C		
Para modelos:	GDW2001		

ø12mm			
con casquillo enchufable			
 <p>1</p>			
código	359042	referencia	A08003
descripción	lámpara de señalización ø 12mm amarillo 230V empalme conector Faston 6,3mm resis.a la temp. 120°C UE 1 pzs		
Para modelos:	GEG2001, GTO1001, GTO2001		

 <p>1</p>			
código	359041	referencia	A08009
descripción	lámpara de señalización ø 12mm verde 230V empalme conector Faston 6,3mm resis.a la temp. 120°C UE 1 pzs		
Para modelos:	GEG2001		

ø14mm			
con casquillo roscado			
 <p>1</p>			
código	360621	referencia	1.03.00020017
descripción	lámpara de señalización ø 14mm amarillo 220V empalme conector Faston 4,8mm plástico		
Para modelos:	GDF3004, GDF3008, GDF3024, GDF3028, GDF5008, GDF5028		



			
1			
código	360622	referencia	1.03.00020013
descripción	lámpara de señalización ø 14mm verde 220V empalme conector Faston 4,8mm plástico		
Para modelos:	GDF3004, GDF3008, GDF3024, GDF3028, GDF5008, GDF5028		

LEDs

barras de LED



1			
código	357257	referencia	DQLED007
descripción	barra de LED L 1100mm An 14.4mm H 7.5mm 24VDC blanco número de lámparas 36 longitud del cable 120mm		
Para modelos:	GSC2336		

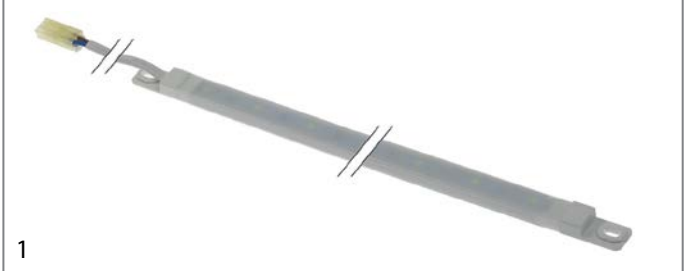

1			
código	357256	referencia	DQLED008
descripción	barra de LED L 1200mm An 14.4mm H 7.5mm 24VDC blanco número de lámparas 42 longitud del cable 120mm		
Para modelos:	GSC1100G		



1			
código	357260	referencia	W0304086 W0304511
descripción	barra de LED L 130mm An 14mm H 8mm longitud del cable 300mm GFR2700/GRE2700		
Para modelos:	GFR2700, GRE2700		
accesorios para	357260		
	código	692879	referencia W0409863
	cubierta para lámpara L 185mm An 55mm H 40mm para GFR2700/GRE2700		

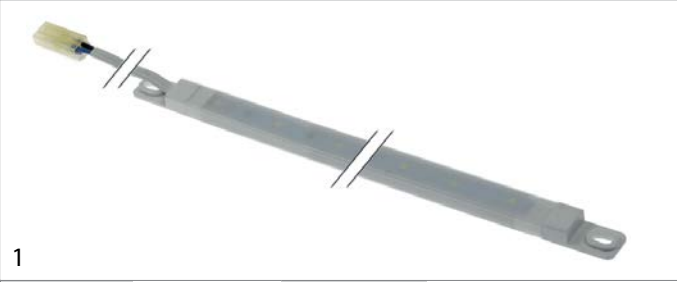

1			
código	357255	referencia	DQLED011
descripción	barra de LED L 370mm An 14.4mm H 7.5mm 24VDC blanco número de lámparas 18 longitud del cable 380mm		
Para modelos:	GSC2336		



1			
código	357251	referencia	DQLED066
descripción	barra de LED L 400mm An 12mm H 12mm 24V azul número de lámparas 30 longitud del cable 280mm		
Para modelos:	GBC1102		



1			
código	357241	referencia	DQLED067
descripción	barra de LED L 600mm An 11.5mm H 12.5mm 24V número de lámparas 42 longitud del cable 285mm tensión DC		
Para modelos:	GBC1103		

1			
código	357138	referencia	1.1.A.A01.03.03
descripción	barra de LED L 698mm An 13mm H 13mm 230V número de lámparas 27 longitud del cable 800mm		
Para modelos:	GCV1600		

accesorios

1			
código	357152	referencia	1.1.B.B25.20
descripción	alimentador para LED RT-130-2-24cm UE 1 pzs		
Para modelos:	GCV1600		



lámparas fluorescentes

lámparas fluorescentes

G5

			
1			
código	357156	referencia	DQDA0009
descripción	lámpara fluorescente casquillo G5 L 285mm 8W ø 16mm 230V T5/865 UE 1 pzs		
Para modelos:	GBC1001, GBC1001S, GBC1001SS		

			
1			
código	357148	referencia	DQDA0010
descripción	lámpara fluorescente casquillo G5 L 547mm 14W ø 16mm 230V T5/865 UE 1 pzs		
Para modelos:	GBC1002, GBC1002S, GBC1002SS, GBC1003, GBC1003S, GBC1003SS		

accesorios

casquillos

			
1			
código	381169	referencia	SLJY2010
descripción	portalámparas casquillo G13 L 26.5mm An 24.5mm UE 1 pzs para lámparas fluorescentes		

			
1			
código	381447	referencia	SLZA3000
descripción	portalámparas casquillo G13 L 33mm An 10mm H 28mm		
Para modelos:	GBC1001, GBC1001S, GBC1001SS, GBC1002, GBC1002S, GBC1002SS, GBC1003, GBC1003S, GBC1003SS		

portacebadores

			
1			
código	381170	referencia	SLZA1000
descripción	portacebador L 32mm An 24mm carcasa ø 23mm UE 1 pzs		
Para modelos:	GBC1001, GBC1001S, GBC1001SS, GBC1002, GBC1002S, GBC1002SS, GBC1003, GBC1003S, GBC1003SS		

cebadores

			
1			
código	380464	referencia	DQDF0000
descripción	cebador 4-65W		
Para modelos:	GBC1001, GBC1001S, GBC1001SS, GBC1002, GBC1002S, GBC1002SS, GBC1003, GBC1003S, GBC1003SS		

			
1			
código	357150	referencia	1.1.A.A01.02.01
descripción	cebador para lámparas fluorescentes L 69mm An 38.5mm 11W tipo HG-YZ11E UE 1 pzs		
Para modelos:	GGC1078, GGC1078B, GGC2270, GGC2270B		

balastos

			
1			
código	403192	referencia	DQZB0005
descripción	balasto eléctrico 15W 220-240V empalme borne roscado para lámparas fluorescentes tipo JF-1595M UE 1 pzs		
Para modelos:	GBC1002, GBC1002S, GBC1002SS, GBC1003, GBC1003S, GBC1003SS		

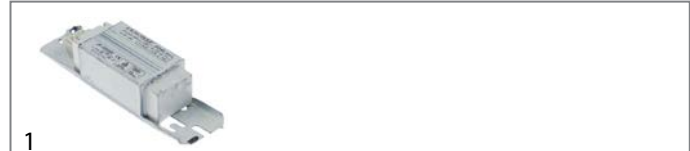
			
1			
código	403190	referencia	DQZA0027
descripción	balasto eléctrico 30W 220-240V empalme borne roscado para lámparas fluorescentes tipo JF-3095W UE 1 pzs		



			
1			
código	403191	referencia	DQZB0029
descripción	balasto eléctrico 9W 220V empalme borne roscado para lámparas fluorescentes tipo JF-995M UE 1 pzs		
Para modelos:	GBC1001, GBC1001S, GBC1001SS		



cubiertas



1

código	694874	referencia	SLZQ0037
descripción	cubierta juego pos. de montaje derecho y izquierdo An 82mm H 280mm P 34		
Para modelos:	GSC1100G, GSC2336		
repuestos para	694874		
	código	692393	referencia —
	revestimiento para cubierta pos. de montaje derecho An 82mm H 280mm P 34mm plástico UE 1 pzs		
	código	692394	referencia —
	revestimiento para cubierta pos. de montaje izquierdo An 82mm H 280mm P 34mm plástico UE 1 pzs		



1

código	699314	referencia	SLZV0017
descripción	cubierta L 510mm An 30mm H 30mm		
Para modelos:	GBC1001, GBC1001S, GBC1001SS		



1

código	694873	referencia	SLSE2008
descripción	cubierta L 590mm An 280mm H 1mm		
Para modelos:	GSC2336		



1

código	699312	referencia	SLZV0018
descripción	cubierta L 810mm An 30mm H 30mm transparente		
Para modelos:	GBC1002, GBC1002S, GBC1002SS, GBC1102		



1

código	694872	referencia	SLJV2040
descripción	cubierta soporte L 610mm An 20mm H 55mm pos. de montaje abajo		
Para modelos:	GSC2336		



1

código	694871	referencia	SLJV2041
descripción	cubierta soporte L 610mm An 20mm H 55mm pos. de montaje arriba		
Para modelos:	GSC2336		

lámparas para microondas

bombillas incandescentes



1

código	357175	referencia	253079000039
descripción	bombilla incandescente casquillo E14 230V 20W ø 25mm L 63mm UE 1 pzs cristal L 37mm		
Para modelos:	GMW1025		



lámparas para hornos

lámparas de horno universales

diámetro de montaje 35,5mm



1

código	359718	referencia	00002330
descripción	lámpara de horno montaje ø 35.5mm 230V 15W casquillo E14 resis.a la temp. 300°C empalme conector Faston 6,3mm vidrio duro		
Para modelos:	GCO2001		
repuestos para	359718		
	código	359701	referencia —
	portalámparas casquillo E14 220-230V montaje ø 35.5mm empalme conector Faston 6,3mm 15W		
	código	359740	referencia —
	bombilla incandescente T máx 300°C casquillo E14 15W 230V ø 22mm L 48mm cristal L 20mm para lámpara de horno IMPORT		



1

código	357176	referencia	LAM30006
descripción	lámpara de horno montaje ø 35.5mm 230V 40W casquillo G9 resis.a la temp. 300°C empalme cable 100mm vidrio duro		
Para modelos:	GCO500		



accesorios para lámparas

paneles

 <p>1</p>							
código	692879	referencia	W0409863				
descripción	cubierta para lámpara L 185mm An 55mm H 40mm para GFR2700/ GRE2700						
Para modelos:	GFR2700, GRE2700						
accesorios para	692879						
 <table border="1"> <tr> <td>código</td> <td>357260</td> <td>referencia</td> <td>W0304086 W0304511</td> </tr> </table> <p>barra de LED L 130mm An 14mm H 8mm longitud del cable 300mm GFR2700/GRE2700</p>				código	357260	referencia	W0304086 W0304511
código	357260	referencia	W0304086 W0304511				

 <p>1</p>			
código	360164	referencia	A02008
descripción	temporizador MT49 2 polos tiempo de funcionamiento 15min accionamiento mecánico 2NO a 250 V 16A posición permanente presente eje 6x4,6mm eje L 16mm distancia de sujeción 28mm empalme lateral		
Para modelos:	GTO1001, GTO2001		

temporizadores

temporizadores mecánicos

 <p>1</p>			
código	350130	referencia	PRG30001
descripción	temporizador M11 con campana 1 polos tiempo de funcionamiento 120min accionamiento mecánico 1NO a 250 V 16A posición permanente presente eje ø 6x4,6mm eje L 23mm distancia de sujeción 28mm rosca de sujeción M4 empalme conector Faston 6,3mm sujeción 4 orificios parte plana arriba		
Para modelos:	GCO500		

temporizador de descongelación

 <p>1</p>			
código	360553	referencia	1.1.A.A05.06
descripción	reloj de descongelación SONXIE tipo DBZF-625-2G2B intervalo de descongelación 6h tiempo de descongelación 2minmin retardo ventiladormin aliment. 200-240V UE 1 pzs		
Para modelos:	GGC1078, GGC1078B		

 <p>1</p>							
código	350186	referencia	01202980				
descripción	temporizador M2 2 polos tiempo de funcionamiento 120min accionamiento mecánico 2CO a 250 V 16A posición permanente presente eje ø 6x4,6mm eje 6x4,6mm eje L 23mm distancia de sujeción 28mm						
Para modelos:	GCO2001						
accesorios para	350186						
 <table border="1"> <tr> <td>código</td> <td>112627</td> <td>referencia</td> <td>—</td> </tr> </table> <p>pomo tiempo 120min ø 58mm eje ø 6x4,6mm parte plana abajo</p>				código	112627	referencia	—
código	112627	referencia	—				

señalizadores de alarma

 <p>1</p>			
código	401062	referencia	01201250
descripción	platina de zumbador 230VAC L 48mm An 45mm empalme Faston 6,3mm		
Para modelos:	GCO2001		



contactores

LOVATO

contactores de potencia



1

código	380705	referencia	907190
descripción	contactor de potencia AC1 20A 230VAC (AC3/400V) 9A/4kW contactos principales 3NO contactos auxiliares 1NO empalme empalme atornillado tipo 11BG0910A230		
Para modelos:	GDW2001		
accesorios para	380705		
	código	380057	referencia
			—
	contacto auxiliar contactos 1NO/1NC AC1 10A para contactores serie BG empalme atornillado tipo BGX1011		

semiconductores de potencia

accesorios

diodos

diodos de alta tension



1

código	403261	referencia	253089000101
descripción	diodo de alta tensión tipo RG501 empalme F6,3mm / ojal M4 longitud del cable mm para microondas UE 1 pzs		
Para modelos:	GMW1025		

relés

relés de potencia

con lengüeta de sujeción



1

código	380867	referencia	DQWBZJ02
descripción	relé SHANGFANG 12VDC 30A 1NO empalme conector Faston 6,3mm fijación atornillada a 250 V 30A N° fabricante 855AW-1A-C1		
Para modelos:	GSC1100G, GSC2336		

magnetrones



1

código	403173	referencia	253017000051
descripción	Magnetron tipo 2M248J(JT)		
Para modelos:	GMW1025		

transformadores

alimentadores



1

código	403903	referencia	W0399114
descripción	alimentador primaria 100-240VAC secundaria 24VDC H 30mm L 85mm An 45mm 50/60Hz tipo JKY36-SP2400600		
Para modelos:	GFR2700		



1

código	403902	referencia	W0399115
descripción	alimentador primaria 100-240VAC secundaria 24VDC H 34mm L 114mm An 45mm 50/60Hz tipo JKY36-SP2401500 GRE2700		
Para modelos:	GRE2700		

transformadores de alta tensión



1

código	403257	referencia	253029000256
descripción	transformador de alta tensión primaria 230-240V 50Hz tipo GAL-1000E-1G para microondas		
Para modelos:	GMW1025		



otros

			
1			
código	403660	referencia	DQLED069
descripción	transformador primaria 100-240V secundaria 24VDC 20VA secundaria 0.84A		
Para modelos:	GBC1001, GBC1001S, GBC1002, GBC1002S, GBC1003, GBC1003S, GBC1102, GBC1103		

			
1			
código	403867	referencia	DQLED055
descripción	transformador primaria 100-240V secundaria 24VDC secundaria 0.42A H 25mm L 95mm An 40mm		
Para modelos:	GSC1100G, GSC2336		

accesorios para	378256		
	código	379343	referencia
			—
	sensor de temperatura NTC 10kOhm cable silicona sonda -40 a +110°C cable -50 a +180°C bulbo ø6x40mm longitud de cable 3m de dos hilos		
	código	379458	referencia
			—
	sensor de temperatura NTC 10kOhm cable silicona sonda -40 a +110°C cable -50 a +180°C bulbo ø6x40mm longitud de cable 1.5m sin racor de dos hilos		

controladores electrónicos

DIXELL

controladores de punto de refrigeración

versión empotrada

			
1			
código	378256	referencia	S900.02
descripción	controlador electrónico DIXELL XR02CX-5N0C0 medida de montaje 71x29mm profundidad de montaje 56mm aliment. 230V tensión AC NTC salidas de relé 1 CO-8A(4) NTC protección IP54 función de descongelación/control temporizado -40 a +110°C display 2½ dígitos		
Para modelos:	GHS1600, GHS2600		
repuestos para	378256		
	código	379161	referencia
			—
	sensor de temperatura NTC 10kOhm cable termoplástico sonda -40 a +110°C cable -40 a +110°C bulbo ø6x14mm longitud de cable 3m sin racor de dos hilos		
accesorios para	378256		
	código	378194	referencia
			—
	sensor de temperatura NTC 10kOhm cable PVC sonda -20 a +80°C cable -10 a 100°C bulbo ø7x24,5mm longitud de cable 1.5m sin racor de dos hilos		
	código	379057	referencia
			—
	sensor de temperatura NTC 10kOhm cable PVC sonda -20 a +80°C cable -10 a 100°C bulbo ø6x25mm longitud de cable 3m de dos hilos		
	código	379160	referencia
			E21010150001
	sensor de temperatura NTC 10kOhm cable termoplástico sonda -40 a +110°C cable -40 a +110°C bulbo ø6x14mm longitud de cable 1.5m sin racor de dos hilos		
	código	379161	referencia
			—
	sensor de temperatura NTC 10kOhm cable termoplástico sonda -40 a +110°C cable -40 a +110°C bulbo ø6x14mm longitud de cable 3m sin racor de dos hilos		

			
1			
código	378267	referencia	E20A111C4D00
descripción	controlador electrónico DIXELL XR02CX-5N0C1 medida de montaje 71x29mm profundidad de montaje 56mm aliment. 230V tensión AC NTC salidas de relé 1 NO-20A(8) NTC DI protección IP54 función de descongelación/control temporizado -40 a +110°C display 2½ dígitos		
Para modelos:	GDS2600, GPS2600, GSA2600, GSD2600, GSF2600		
accesorios para	378267		
	código	379161	referencia
			—
	sensor de temperatura NTC 10kOhm cable termoplástico sonda -40 a +110°C cable -40 a +110°C bulbo ø6x14mm longitud de cable 3m sin racor de dos hilos		
	código	381249	referencia
			—
	sensor de temperatura NTC 10kOhm cable PVC sonda -40 a +110°C cable -10 a 100°C empalme de dos hilos rosca bulbo ø6x14mm longitud de cable 3m		

			
1			
código	378665	referencia	W0302160
descripción	controlador electrónico DIXELL XR03CX-5R0C1 medida de montaje 71x29mm profundidad de montaje 50mm aliment. 230V tensión AC NTC salidas de relé 2 NO-20A(8) CO-8A(3) NTC DI protección IP65 función de descongelación/control temporizado -55 a +99°C display 2 dígitos		
Para modelos:	GRE2700		

			
1			
código	378363	referencia	W0302159
descripción	controlador electrónico DIXELL XR06CX-5R0C1 medida de montaje 71x29mm aliment. 230V tensión AC NTC salidas de relé 3 NO-20A(8) CO-8A(3) NO-5A(2) NTC NTC DI protección IP54 -40 a +110°C display 3½ dígitos		
Para modelos:	GFR2700		
accesorios para	378363		
	código	381249	referencia
			—
	sensor de temperatura NTC 10kOhm cable PVC sonda -40 a +110°C cable -10 a 100°C empalme de dos hilos rosca bulbo ø6x14mm longitud de cable 3m		



1

código	379843 ¹	referencia	1.1.A.A06.03.31
descripción	kit controlador electrónico DIXELL XR30CX-5N2C1 medida de montaje 71x29mm aliment. 230V tensión AC NTC/PTC salidas de relé 2 incl. 1x sensor NTC -50 a +150°C display 3½ dígitos 2 TempAmbIN NTC/PTC sonda DEF DigiIN1 DigiIN2 DEF Relay relé ventilador Temp4/Dig1 NTC/PTC/DIG1 sensor de evaporador func. descon. relé compresor NO-20A(8) relé fotoeléctrico relé de alarma CO-8A(3) relé auxiliar		
Para modelos:	GCV1600		
repuestos para	379843		
	código	referencia	E21010150001
	sensor de temperatura NTC 10kOhm cable termoplástico sonda -40 a +110°C cable -40 a +110°C bulbo ø6x14mm longitud de cable 1.5m sin racor de dos hilos		

¹con 1x sensor NTC

SHANGFANG

controladores de punto de refrigeración

versión empotrada

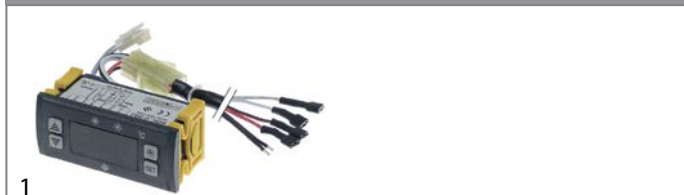

1

código	379799 ¹	referencia	DQWBZX02
descripción	controlador electrónico SHANGFANG tipo SF-104S-2 medida de montaje 71x29mm aliment. 12V tensión AC NTC salidas de relé 2 12VDC 12VDC NTC dimensiones frontales 77x35mm profundidad de montaje 40mm protección IP54 precisión 1% versión empotrada alarma sin accesorios func. descon. presente -45 a +45°C display 3 dígitos		
Para modelos:	GSC1100G, GSC2336		
repuestos para	379799		
	código	referencia	—
	transformador primaria 230VAC secundaria 12VAC 3VA secundaria 0.25A H 40mm L 45mm An 50mm empalme atornillado 50/60Hz tipo 153/M		
	código	referencia	DQWBZJ02
	relé SHANGFANG 12VDC 30A 1NO empalme conector Faston 6,3mm fijación atornillada a 250 V 30A N° fabricante 855AW-1A-C1		
	código	referencia	—
	sensor de temperatura NTC cable silicona colores cable blanco longitud de cable 3m sonda -40 a +110°C cable -50 a +180°C bulbo ø7x25mm conector codificado		
	código	referencia	—
	sensor de temperatura NTC cable silicona colores cable negro longitud de cable 3m evaporador sonda -40 a +110°C cable -50 a +180°C bulbo ø7x25mm conector codificado		
accesorios para	379799		
	código	referencia	—
	transformador primaria 230VAC secundaria 12VAC 3VA secundaria 0.25A H 40mm L 45mm An 50mm empalme atornillado 50/60Hz tipo 153/M		

¹sin relé, mazo de cables, sensor y transformador

accesorios para	379799		
	código	referencia	DQWBZJ02
	relé SHANGFANG 12VDC 30A 1NO empalme conector Faston 6,3mm fijación atornillada a 250 V 30A N° fabricante 855AW-1A-C1		
	código	referencia	—
	sensor de temperatura NTC cable silicona colores cable blanco longitud de cable 3m sonda -40 a +110°C cable -50 a +180°C bulbo ø7x25mm conector codificado		
	código	referencia	—
	sensor de temperatura NTC cable silicona colores cable negro longitud de cable 3m evaporador sonda -40 a +110°C cable -50 a +180°C bulbo ø7x25mm conector codificado		

versión empotrada 2 piezas



1

código	379849 ¹	referencia	DQWB0005
descripción	controlador electrónico SHANGFANG tipo SF-101S medida de montaje 71x29mm aliment. 230V tensión AC NTC salidas de relé 1 NO-30A NTC Comp dimensiones frontales 77x35mm profundidad de montaje 40mm protección IP54 precisión 1% versión empotrada alarma con relé, mazo de cables, sensor y transformador func. descon. presente -45 a +45°C display 3 dígitos		
Para modelos:	GBC1001, GBC1001S, GBC1001SS, GBC1002, GBC1002S, GBC1002SS, GBC1003, GBC1003S, GBC1003SS		
repuestos para	379849		
	código	referencia	—
	transformador primaria 230VAC secundaria 12VAC 3VA secundaria 0.25A H 40mm L 45mm An 50mm empalme atornillado 50/60Hz tipo 153/M		
	código	referencia	DQWBZJ02
	relé SHANGFANG 12VDC 30A 1NO empalme conector Faston 6,3mm fijación atornillada a 250 V 30A N° fabricante 855AW-1A-C1		
	código	referencia	—
	sensor de temperatura NTC cable silicona colores cable blanco longitud de cable 3m sonda -40 a +110°C cable -50 a +180°C bulbo ø7x25mm conector codificado		
	código	referencia	—
	sensor de temperatura NTC cable silicona colores cable negro longitud de cable 3m evaporador sonda -40 a +110°C cable -50 a +180°C bulbo ø7x25mm conector codificado		
accesorios para	379849		
	código	referencia	—
	transformador primaria 230VAC secundaria 12VAC 3VA secundaria 0.25A H 40mm L 45mm An 50mm empalme atornillado 50/60Hz tipo 153/M		
	código	referencia	DQWBZJ02
	relé SHANGFANG 12VDC 30A 1NO empalme conector Faston 6,3mm fijación atornillada a 250 V 30A N° fabricante 855AW-1A-C1		
	código	referencia	—
	sensor de temperatura NTC cable silicona colores cable blanco longitud de cable 3m sonda -40 a +110°C cable -50 a +180°C bulbo ø7x25mm conector codificado		
	código	referencia	—
	sensor de temperatura NTC cable silicona colores cable negro longitud de cable 3m evaporador sonda -40 a +110°C cable -50 a +180°C bulbo ø7x25mm conector codificado		

¹con relé, mazo de cables, sensor y transformador



<p>71 x 29mm</p>			
1	código	403074 ¹	referencia DQWB0002
descripción	controlador electrónico SHANGFANG tipo SF-104S-2 medida de montaje 71x29mm aliment. 230V tensión AC NTC salidas de relé 2 NO-30A NO-30A NTC NTC dimensiones frontales 77x35mm profundidad de montaje 38mm protección IP54 precisión 1% versión empotrada alarma con relé, mazo de cables, sensor y transformador func. descon. presente -45 a +45°C display 2½ dígitos		
Para modelos:	GBC1001, GBC1001S, GBC1002, GBC1002S, GBC1003, GBC1003S, GBC1102, GBC1103, GSC1100G, GSC2336		
repuestos para	403074		
	código	379054	referencia —
	transformador primaria 230VAC secundaria 12VAC 3VA secundaria 0.25A H 40mm L 45mm An 50mm empalme atornillado 50/60Hz tipo 153/M		
	código	380867	referencia DQWBZJ02
	relé SHANGFANG 12VDC 30A 1NO empalme conector Faston 6,3mm fijación atornillada a 250 V 30A N° fabricante 855AW-1A-C1		
	código	381318	referencia —
	sensor de temperatura NTC cable silicona colores cable blanco longitud de cable 3m sonda -40 a +110°C cable -50 a +180°C bulbo ø7x25mm conector codificado		
	código	381319	referencia —
	sensor de temperatura NTC cable silicona colores cable negro longitud de cable 3m evaporador sonda -40 a +110°C cable -50 a +180°C bulbo ø7x25mm conector codificado		
accesorios para	403074		
	código	379054	referencia —
	transformador primaria 230VAC secundaria 12VAC 3VA secundaria 0.25A H 40mm L 45mm An 50mm empalme atornillado 50/60Hz tipo 153/M		
	código	380867	referencia DQWBZJ02
	relé SHANGFANG 12VDC 30A 1NO empalme conector Faston 6,3mm fijación atornillada a 250 V 30A N° fabricante 855AW-1A-C1		
	código	381318	referencia —
	sensor de temperatura NTC cable silicona colores cable blanco longitud de cable 3m sonda -40 a +110°C cable -50 a +180°C bulbo ø7x25mm conector codificado		
	código	381319	referencia —
	sensor de temperatura NTC cable silicona colores cable negro longitud de cable 3m evaporador sonda -40 a +110°C cable -50 a +180°C bulbo ø7x25mm conector codificado		

¹con relé, mazo de cables, sensor y transformador

accesorios

<p>1</p>			
código	380867	referencia	DQWBZJ02
descripción	relé SHANGFANG 12VDC 30A 1NO empalme conector Faston 6,3mm fijación atornillada a 250 V 30A N° fabricante 855AW-1A-C1		
Para modelos:	GSC1100G, GSC2336		

accesorios en general para controladores

otros

<p>1</p>			
código	692369	referencia	1.1.C.C63.71
descripción	soporte per termómetro An 81mm H 41mm plástico UE 1 pzs		
Para modelos:	GCV1600		

sensores

sensores universales

sondas de temperatura

<p>1</p>			
código	379160	referencia	E21010150001
descripción	sensor de temperatura NTC 10kOhm cable termoplástico sonda -40 a +110°C cable -40 a +110°C bulbo ø6x14mm longitud de cable 1.5m sin racor de dos hilos		
Para modelos:	GDS2600, GPS2600, GSA2600, GSD2600, GSF2600		

sensores específicos del fabricante

sensores

<p>1</p>			
código	403899	referencia	W0302305
descripción	sensor NTC 10kOhm cable PVC sonda -40 a +110°C cable -40 a +110°C empalme conector codificado rosca bulbo ø6x14mm longitud de cable 600m GFR2700/GRE2700		
Para modelos:	GFR2700		

<p>1</p>			
código	403901	referencia	W0302304
descripción	sensor NTC 10kOhm cable PVC sonda -40 a +110°C cable -40 a +110°C empalme conector codificado rosca bulbo ø6x14mm longitud de cable 800m GFR2700/GRE2700		
Para modelos:	GFR2700, GRE2700		



1 

código	403910	referencia	I0205805
descripción	sensor de temperatura NTC 10kOhm cable PVC sonda -40 a +110°C empalme de dos hilos bulbo 5x20 longitud de cable 1.475m		
Para modelos:	GFR3600S, GRE3600, GRE3600S		

sensores

1 

código	403155	referencia	AD400009
descripción	sensor para aparato de inducción ø 25mm H 17mm longitud del cable 130mm		
Para modelos:	GIC3035		

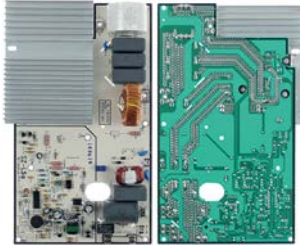
1 

código	403153	referencia	DQA010095R	
descripción	placa base aparato de inducción GIC3035 L 267mm An 160mm empalme conector Faston 6,3mm vertical empalme de teclado 4 pins de contacto SZ-L5			
Para modelos:	GIC3035			
accesorios para	403153			
	código	403154	referencia	DQA020110R
	placa de teclado aparato de inducción GIC3035 L 247mm An 53mm empalme de teclado 4 pins de contacto edición desde 2012 tazas 8			

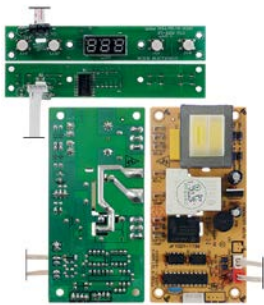

1 

código	361873	referencia	1.1.A.A17.01.01 1.1.A.A17.04.06
descripción	placa de control escaparate refrigerado GGC 1270/2270 longitud del cable 225mm 2 piezas tipo KB3150		
Para modelos:	GGC2270, GGC2270B		

1 

código	403529	referencia	263019008956
descripción	placa de display microondas GMW1025 L 160mm An 85mm longitud del cable 200mm para microondas		
Para modelos:	GMW1025		

1 

código	403154	referencia	DQA020110R	
descripción	placa de teclado aparato de inducción GIC3035 L 247mm An 53mm empalme de teclado 4 pins de contacto edición desde 2012 tazas 8			
Para modelos:	GIC3035			
accesorios para	403154			
	código	403156	referencia	LAC5000003
	panel de mando aparato de inducción GIC3535 An 300mm H 58mm			
	código	403160	referencia	—
	panel de mando aparato de inducción GIC3535 An 300mm pos. de montaje derecho H 58mm			

electrónicas

placas electrónicas

1 

código	403188	referencia	263029001088
descripción	filtro de red microondas para GMW1025 250V 50/60Hz conductor 2 placa electrónica empalme conector Faston 4,8mm L 80mm H 20mm An 40mm placa electrónica UE 1 pzs longitud del cable 120mm tipo DNV-0818A-5		
Para modelos:	GMW1025		

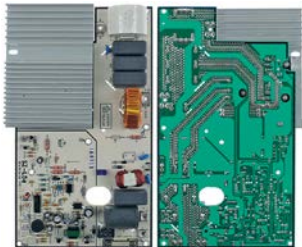
1 

código	403680	referencia	DQA010198R
descripción	placa base aparato de inducción GIC3035 L 267mm An 160mm empalme atornillado empalme de teclado 4 pins de contacto SZ-L5a		
Para modelos:	GIC3035		

1

código	403165	referencia	2852
descripción	placa electrónica GSM1000 regulación de revoluciones		
Para modelos:	GSM1000		
repuestos para	403165		
	código	referencia	2858
	pomo para placa electrónica ø 26mm negro UE 1 pzs		



1

código	403954	referencia	I9R00462
descripción	platina de control refrigeración IARP L 222mm An 40mm		
Para modelos:	GFR3600S		



1

código	403736	referencia	43845000
descripción	platina de control refrigeración IARP L 222mm An 40mm para frigorífico		
Para modelos:	GRE3600, GRE3600S		

unidades centrales



1

código	401855	referencia	0000009240
descripción	caja electrónica con interruptor a presión doble para cortadora de fiambre 230V		
Para modelos:	GFS1030		



1

código	400788	referencia	0000000297
descripción	caja electrónica para cortadora de fiambre 230V		
Para modelos:	GFS1022, GFS1025, GFS1030, GFS2022, GFS2025		



1

código	403682	referencia	0000001752
descripción	caja electrónica para cortadora de fiambre 230V 50Hz edición desde 04/2016		
Para modelos:	GFS2019, GFS2030		

teclados

membranas de teclado



1

código	403764	referencia	49357000
descripción	membrana de teclado congelador instantáneo L 165mm An 45mm		
Para modelos:	GFR3600S, GRE3600, GRE3600S		



1

código	403156	referencia	LAC5000003
descripción	panel de mando aparato de inducción GIC3535 An 300mm H 58mm		
Para modelos:	GIC3035		
accesorios para	403156		
	código	referencia	DQA020110R
	placa de teclado aparato de inducción GIC3035 L 247mm An 53mm empalme de teclado 4 pins de contacto edición desde 2012 tazas 8		



teclados de membrana



1

código	403187	referencia	253069002692
descripción	teclado de membrana microondas GMW1025 2 piezas tazas 15 UE 1 pzs L 164mm An 70mm		
Para modelos:	GMW1025		

paneles de mando



1

código	506281	referencia	909763
descripción	panel de mando para lavavajillas L 250mm An 40mm negro para Silanos		
Para modelos:	GDW2001		

válvulas magnéticas

válvulas magnéticas agua

TP



1

código	370017	referencia	902390
descripción	válvula magnética simple recto 230VAC entrada 3/4" salida 11,5mm DN10 TP p máx. 10bar		
Para modelos:	GDW2001		

repuestos para	370017		
-----------------------	--------	--	--

	código	371013	referencia	—
		bobina magnética TP 230VAC 50/60Hz		

accesorios para	370017		
------------------------	--------	--	--













	código	371220	referencia	—
		reducción TP velocidad de flujo 3l/min rojo tolerancia ±15%		

	código	371221	referencia	—
		reducción TP velocidad de flujo 5.5l/min amarillo tolerancia ±15%		

	código	371222	referencia	—
		reducción TP velocidad de flujo 6l/min gris tolerancia ±15%		

	código	371223	referencia	—
		reducción TP velocidad de flujo 10l/min blanco tolerancia ±15%		

	código	371224	referencia	—
		reducción TP velocidad de flujo 12l/min bronce tolerancia ±15%		

accesorios para	370017			
	código	371225	referencia	—
		reducción TP velocidad de flujo 16l/min marrón claro tolerancia ±15%		
	código	371226	referencia	—
		reducción TP velocidad de flujo 20l/min rojo tolerancia ±15%		
	código	371230	referencia	—
		reducción TP velocidad de flujo 0.25l/min rojo tolerancia ±25%		
	código	371231	referencia	—
		reducción TP velocidad de flujo 0.35l/min violeta tolerancia ±25%		
	código	371232	referencia	—
		reducción TP velocidad de flujo 0.5l/min naranja tolerancia ±25%		
	código	371233	referencia	—
		reducción TP velocidad de flujo 0.8l/min blanco tolerancia ±25%		
	código	371234	referencia	—
		reducción TP velocidad de flujo 1l/min azul claro tolerancia ±25%		
	código	371235	referencia	—
		reducción TP velocidad de flujo 1.2l/min marrón tolerancia ±25%		
	código	371236	referencia	—
		reducción TP velocidad de flujo 1.5l/min marrón claro tolerancia ±25%		
	código	371237	referencia	—
		reducción TP velocidad de flujo 2.5l/min amarillo tolerancia ±25%		
	código	371238	referencia	—
		reducción TP velocidad de flujo 3.4l/min verde oscuro tolerancia ±25%		
	código	371239	referencia	—
		reducción TP velocidad de flujo 5l/min negro tolerancia ±25%		
	código	371240	referencia	—
		reducción TP velocidad de flujo 8l/min azul tolerancia ±20%		

válvulas magnéticas refrigeración

SANHUA

válvulas



1

código	374110	referencia	W0205011	
descripción	válvula magnética tipo FDF2AT empalme 6mm conexión para soldadura L 143mm empalme de tubo ø 6mm 220-240V			
Para modelos:	GFR2700			
accesorios para	374110			
	código	696787	referencia	W0208009
		pieza T cobre int.ø 4.5mm ø ext. 6mm refrigeración para GFR2700		

presostatos

para sistemas de lavado

ø58mm con conector Faston 6,3mm

con empalme horizontal



1

código	541001	referencia	905264
descripción	presostato margen de presión 35/17mbar empalme 6mm ø 58mm conexión de presión horizontal sistemas de lavado		
Para modelos:	GDW2001		

compresores

ACC/ZEL

R600A

LBP monofásico

Temperatura baja de evaporación inferior a -20°C



1

código	605141	referencia	DQYD0015 E27B6F1Z0001
descripción	compresor refrigerante R600a tipo HPY12AAa 220-240V 50Hz LBP 8.8kg 1/5HP capacidad cilindro 12 cm ³ RSIR H 200mmWWWWWWWWW		
Para modelos:	GBC1002, GBC1002S, GBC1002SS, GBC1003, GBC1003S, GBC1003SS, GBC1102, GDS2600, GPS2600, GSA2600, GSC2336, GSD2600, GSF2600		



1

código	605150	referencia	1.1.A.A02.01
descripción	compresor refrigerante R600a tipo HVM10AA 220-240V 50Hz LBP 8.7kg 1/6HP capacidad cilindro 10 cm ³ RSIR H 180mmWWWWWWWWW		
Para modelos:	GCV1600		



1

código	650150	referencia	VRX1560.01
descripción	compresor refrigerante R600a tipo HVM67AA 220-240V 50Hz LBP 7.5kg 1/8HP capacidad cilindro 7 cm ³ RSIR H 180mmWWWWW		
Para modelos:	GHS1600, GHS2600		



1

código	605142	referencia	1.1.A.A02.04 DQYD0014
descripción	compresor refrigerante R600a tipo HVM86AA 220-240V 50Hz LBP completamente hermético 7.83kg 01. JulHP capacidad cilindro 8.6 cm ³ RSIR H 174mmWWWWW		
Para modelos:	GBC1001, GBC1001S, GBC1001SS, GGC1078, GGC1078B		

**EMBRACO / ASPERA****R290A**

LBP monofásico

Temperatura baja de evaporación inferior a -20°C

código	605258	referencia	I0210981 W0201133
descripción	compresor refrigerante R290 tipo EMTE2134U 220-240V 50Hz LBP 9kg 3/8HP capacidad cilindro 9.5 cm ³ CSIR H 187mm 250W 278W 305W 330W 366WWWWWW		
Para modelos:	GFR2700, GFR3600S		

R600A

LBP monofásico

Temperatura baja de evaporación inferior a -20°C

código	605281	referencia	W0201151
descripción	compresor refrigerante R600a tipo EMB40CLC 220-240V 50Hz LBP 8kg 1HP capacidad cilindro 7.24 cm ³ H 160mmWWWW		
Para modelos:	GRE2700		

COMPRESORES MAKRO-PROFESSIONAL

código	605257	referencia	45004031
descripción	compresor refrigerante R600a tipo EMD46CLT 220-240V 50Hz LBP 7.5kgHP capacidad cilindro 7.96 cm ³ RSCR H 210mm 88W 118W 154W 196W 246WWWW		
Para modelos:	GRE3600, GRE3600S		

otros**R134A**

código	605140	referencia	DQYA0087
descripción	compresor KONOR tipo GQR90AA refrigerante R134a 220-240V 50Hz 10.1kg 1/4HP capacidad cilindro 9.1 cm ³ RSIR H 186mmWWWWWWWW		

R600A

código	605143	referencia	1.1.A.A02.25
descripción	compresor DONPER tipo QD167YU refrigerante R600a 220-240V 50Hz completamente hermético 11.9kg 3/8HP capacidad cilindro 16.7 cm ³ RSCR H 220mm 169W 199W 236W 280W 334W 391WWWWWW metodo de test ASHRAE condensador 6µF		
Para modelos:	GGC2270, GGC2270B		



accesorios

otros



1

código	699425	referencia	1.1.C.C41.01
descripción	amortiguador de vibraciones ø 25mm H 10mm		
Para modelos:	GGC1078, GGC1078B		

ventiladores

ventilador axial

importación



1

código	601131 ¹	referencia	I0221151
descripción	ventilador axial L 119mm An 119mm H 25mm 230VAC 50/60Hz 19/18W cojinete rodamiento de bolas empalme conector Faston 2,8mm metal ADDA rodete ventilador ø 110mm resis.a la temp. 70°C		
Para modelos:	GFR3600S, GRE3600, GRE3600S		
accesorios para	601131		
	código	referencia	550898 I0221181
	cable de conexión longitud del cable 2000mm empalme F 2,8 distancia de empalme 7.9mm para ventilador axial		

¹con rodamiento de bolas



1

código	601909 ¹	referencia	45003031
descripción	ventilador axial L 119mm An 119mm H 38mm 220-240 50/60Hz 31/29W cojinete rodamiento de bolas empalme conector Faston 2,8mm		
Para modelos:	GFR3600S, GRE3600, GRE3600S		

¹con rodamiento de bolas



1

código	601834 ¹	referencia	1.1.A.A03.01.31
descripción	ventilador axial L 119mm An 119mm H 38mm 230VAC 50/60Hz 16/15W cojinete rodamiento de bolas N° fabricante RAM1238B1 empalme cable longitud del cable 900mm XINRUILIAN rodete ventilador ø 110mm resis.a la temp. -10 a +70°C consumo de corriente 0.16A		
Para modelos:	GCV1600		

¹con rodamiento de bolas



1

código	601604 ¹	referencia	E17A1A010100 S900.34
descripción	ventilador axial L 119mm An 119mm H 38mm 230VAC 50/60Hz 17/15W cojinete cojinete de fricción N° fabricante AA1282HS-AT empalme cable 300mm rodete ventilador ø 110mm resis.a la temp. 70°C consumo de corriente 0.1A caudal 130m ³ /h 2600rev/min		
Para modelos:	GDS2600, GHS1600, GHS2600, GPS2600, GSA2600, GSD2600, GSF2600		

¹con cojinete de fricción



1

código	602136	referencia	DQFD2003
descripción	ventilador axial L 119mm An 119mm H 38mm 230VAC 50/60Hz 22/38,4W cojinete cojinete de fricción N° fabricante HT-A12038S220 empalme con cable 500mm longitud del cable 300mm HUI TONG rodete ventilador ø 110mm consumo de corriente 0,1/0,16A carcasa aluminio		
Para modelos:	GBC1001, GBC1001S, GBC1001SS, GBC1002, GBC1002S, GBC1002SS, GBC1003, GBC1003S, GBC1003SS, GBC1102, GBC1103		



			
1			
código	601787 ¹	referencia	DQFA1000 DQFD1000 DQFD1001
descripción	ventilador axial L 119mm An 119mm H 38mm 230VAC 50/60Hz 22/38,4W cojinete cojinete de fricción N° fabricante HT-A120385220 empalme conector longitud del cable 300mm HUI TONG rodete ventilador ø 110mm consumo de corriente 0,1/0,16A carcasa aluminio		
Para modelos:	GBC1001, GBC1001S, GBC1001SS, GSC1100G, GSC2336		

¹con cojinete de fricción

accesorios

rejillas ventiladores

			
1			
código	691104	referencia	I0427017 WJFZ0007
descripción	rejilla de protección ø 115mm distancia de sujeción 105mm para ventilador axial 119mm		
Para modelos:	GBC1001, GBC1001S, GBC1001SS, GBC1002, GBC1002S, GBC1002SS, GBC1003, GBC1003S, GBC1003SS, GBC1102, GBC1103, GRE3600, GRE3600S, GSC2336		

cables de conexión

			
1			
código	550898	referencia	I0221181
descripción	cable de conexión longitud del cable 2000mm empalme F 2,8 distancia de empalme 7.9mm para ventilador axial		
Para modelos:	GRE3600, GRE3600S		

ventiladores para frigoríficos

motores refrigeración universales

ebm-papst

otros

			
1			
código	601783	referencia	E17A1A050500
descripción	motor de ventilador 10W 230V 50/60Hz L3 87mm An 67mm longitud del cable 400mm 1300rev/min ebm-papst M4Q045-CA03-51/C18 3 opciones de sujeción cojinete cojinete de fricción para mesas frías		
Para modelos:	GDS2600, GPS2600, GSA2600, GSD2600, GSF2600		
repuestos para	601783		
		código	601413
		referencia	—
	placa de sujeción apto para rodete ventilador ø ext. 32mm eje ø 7 distancia de sujeción 26mm		
accesorios para	601783		
		código	601385
		referencia	E181A1723401
	rodete ventilador aspirante ø 172mm fijación asta 25.4mm inclinación de la pala 34° An 42mm aluminio		

IMPORTACIÓN

motores multianclaje WEIGUANG

			
1			
código	601020	referencia	W0301906 W0301911
descripción	motor de ventilador 5W 230V 50-60Hz L1 44mm L2 48mm L3 79mm An 84mm longitud del cable 500mm 1300rev/min YZF5-13-18/26 5 opciones de montaje cojinete cojinete de fricción		
Para modelos:	GFR2700, GRE2700		

otros



1

código	601789	referencia	1.1.A.A03.01.10
descripción	motor de ventilador 10W 220-240V 50/60Hz L1 83mm L2 92mm An 84mm longitud del cable 1000mm 1300/1550rev/min WEIGUANG YZF10-20		
Para modelos:	GGC2270, GGC2270B		
repuestos para	601789		
	código	601413	referencia
			—
	placa de sujeción apto para rodete ventilador ø ext. 32mm eje ø 7 distancia de sujeción 26mm		

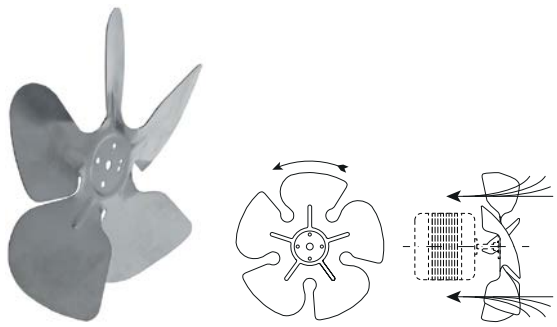

1

código	601070	referencia	1.1.A.A03.03.05 W0301060
descripción	rodete ventilador aspirante ø 200mm fijación asta 25.4mm inclinación de la pala 28° An 38mm aluminio		
Para modelos:	GFR2700, GGC2270, GGC2270B, GRE2700		

accesorios

rodetes de ventilador

aluminio

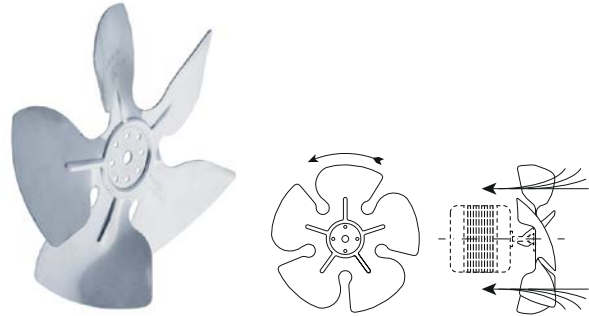

1

código	601553	referencia	W0301078
descripción	rodete ventilador aspirante ø 172mm fijación asta 25.4mm inclinación de la pala 28° An 35mm aluminio		
Para modelos:	GFR2700, GRE2700		

rejillas ventiladores



1

código	602101	referencia	E192A1200300 E192A1723800
descripción	rejilla de protección ø 210mm H 35mm distancia de sujeción 1 230mm distancia de sujeción 2 100mm		
Para modelos:	GDS2600, GPS2600, GSA2600, GSD2600, GSF2600		



1

código	601385	referencia	E181A1723401
descripción	rodete ventilador aspirante ø 172mm fijación asta 25.4mm inclinación de la pala 34° An 42mm aluminio		
Para modelos:	GDS2600, GPS2600, GSA2600, GSD2600, GSF2600		

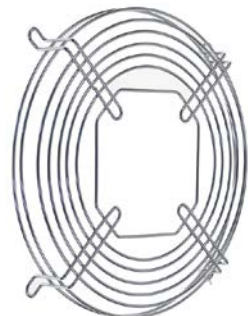

1

código	699432	referencia	1.1.B.B10.36
descripción	rejilla de protección ø 215mm distancia de sujeción 230mm		
Para modelos:	GGC2270, GGC2270B		



motores de refrigeración completos



1

código	602174	referencia	W0301913
descripción	ventilador 220-240V 7W 50/60Hz rodete ventilador ø 170mm empalme cable 350mm 1300rev/min GFR2700/GRE2700		
Para modelos:	GFR2700, GRE2700		
accesorios para	602174		
	código	699579	referencia 80021501
	soporte para ventilador para evaporador L 130mm An 80mm dist. del agujero 63mm para GFR2700/GRE2700		



1

código	601836	referencia	DQJB2004
descripción	ventilador 220V 25/3W 50/60Hz rodete ventilador ø 172mm L 82mm An 82mm empalme terminal de horquilla M4 longitud del cable 1000mm		
Para modelos:	GBC1002, GBC1002S, GBC1002SS, GBC1003, GBC1003S, GBC1003SS, GBC1102, GBC1103		



1

código	601835	referencia	DQJB2013
descripción	ventilador 220V 35/5W 50/60Hz L 82mm An 82mm empalme terminal de horquilla M4 longitud del cable 1100mm		
repuestos para	601835		
	código	602184	referencia —
	placa de sujeción apto para rodete ventilador ø ext. 33mm eje ø 6 distancia de sujeción 17mm		



1

código	601791	referencia	1.1.A.A03.02.04
descripción	motor de ventilador par 220-240V 10W 50Hz rodete ventilador ø 110mm distancia de sujeción 137mm longitud del cable 800mm		
Para modelos:	GGC2270, GGC2270B		

ventiladores de refrigeración

ventiladores de refrigeración



1

código	601845	referencia	1.1.A.A03.01.08
descripción	motor de ventilador 220-240V 50Hz IN 22W / OUT 5W eje ø 4mm eje L 20/48mm L 65mm An 66mm H 73mm UE 1 pzs		
Para modelos:	GGC1078, GGC1078B		
accesorios para	601845		

	código	601846	referencia	1.1.C.C17.04
	rodete ventilador soplado ø 150mm soporte de eje ø 4mm An 33mm plástico UE 1 pzs			

accesorios

aspas para ventiladores de refrigeración



1

código	601846	referencia	1.1.C.C17.04
descripción	rodete ventilador soplado ø 150mm soporte de eje ø 4mm An 33mm plástico UE 1 pzs		
Para modelos:	GGC1078, GGC1078B		

ventiladores tangenciales

EMMEVI - FERGAS

con bobina estándar



1

código	601018	referencia	01202330
descripción	ventilador tangencial TG 180 rodillo ϕ 60mm L rodillo 180mm posición del motor derecho 230V/50Hz 25W universal cojinete silicona empalme conector Faston 6,3mm -10 a +60°C 230V empalmes 1-2 1950U/min empalmes 1-4 1500U/min		
Para modelos:	GCO2001		

accesorios para ventiladores tangenciales

conductos de aire



1

código	701630	referencia	00012330
descripción	conducto de aire para soplador transversal para horno a vapor combinado plástico gris		
Para modelos:	GCO2001		

ventiladores de aire caliente

otros



1

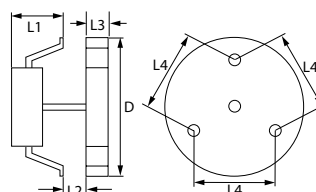

código	500902	referencia	MOT30029	
descripción	motor de ventilador 220V 55W 50/60Hz L1 68mm FIME tipo L25R sin rodete de ventilador			
Para modelos:	GCO500			
accesorios para	500902			
	código	550879	referencia	—
	aislamiento ϕ 130mm espesor 3mm agujero ϕ 18mm para ventilador aire caliente			



1

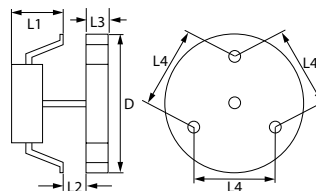

código	602100	referencia	01203230
descripción	ventilador de aire caliente 240V 59W 50/60Hz L1 80mm L2 16mm rodete ventilador ϕ 150mm IMS tipo 138251		
Para modelos:	GCO2001		

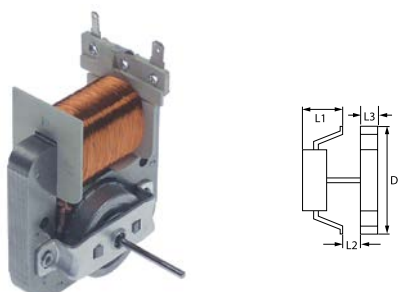

1

código	601838	referencia	278009000033
descripción	motor de ventilador 220-240V 18W 2500rev/min L1 33mm L2 12mm L3 15mm L4mm rodete ventilador ø 120mm eje 2x2,5mm GALANZ tipo GAL6309E(30)-ZD UE 1 pzs		
Para modelos:	GMW1025		



1

código	601827	referencia	DQB000019R
descripción	ventilador de aire caliente 18V 2750rev/min L1 6mm L2mm L3 16mm L4mm rodete ventilador ø 85mm tipo YHWF-85		
Para modelos:	GIC3035		

accesorios

rodetes de ventilador para ventiladores de aire caliente



1

código	601839	referencia	223149000014
descripción	rodete ventilador ø 120mm An 32mm soporte de eje ø 2x2,5mm plástico palas 4 UE 1 pzs		
Para modelos:	GMW1025		



1

código	601261	referencia	VEN30013
descripción	rodete ventilador ø 154mm An 25mm soporte de eje ø 6x5mm cromado palas 7		
Para modelos:	GCO500		

otros



1

código	601840	referencia	223139000011
descripción	soporte ø 130mm L 135mm An 130mm para ventilador aire caliente UE 1 pzs		
Para modelos:	GMW1025		

reguladores de revoluciones

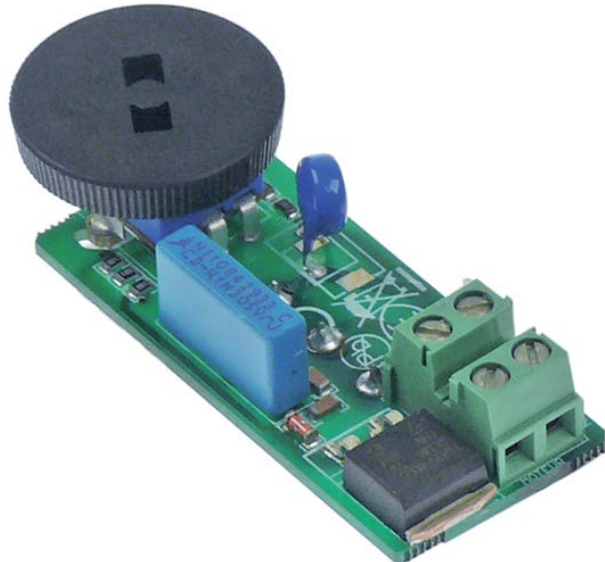

1

código	403165	referencia	2852
descripción	placa electrónica GSM1000 regulación de revoluciones		
Para modelos:	GSM1000		
repuestos para	403165		
	código	696506	referencia 2858
	pomo para placa electrónica ø 26mm negro UE 1 pzs		

motores

motorreductores

para microondas



1

código	601867	referencia	278019000017
descripción	motorreductor GALANZ tipo GAL-33-30-TD(B) 4W 30V tensión AC 50/60Hz 33/40rev/min árbol ø 6x3,5mm para microondas UE 1 pzs		
Para modelos:	GMW1025		

motores

para cortadoras de fiambre

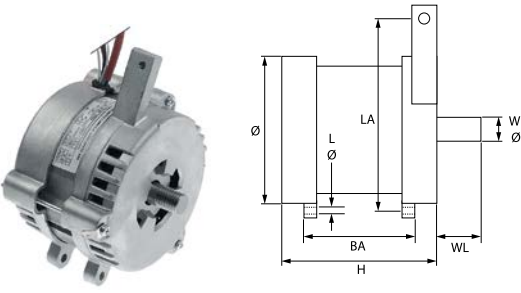

1

código	501530	referencia	00000001753
descripción	motor 230V fases 1 50Hz 1380rev/min árbol ø 15mm longitud árbol 25mm 195-220 edición desde 04/2016		
Para modelos:	GFS2019		

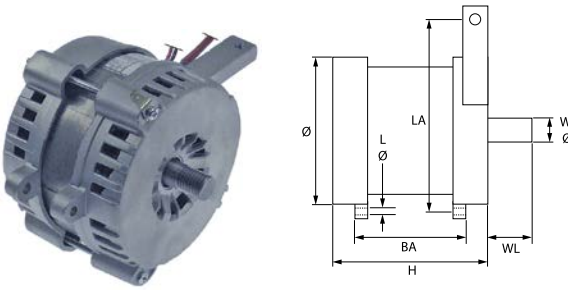

1

código	501427	referencia	00000700283
descripción	motor 230V fases 1 50Hz 1380rev/min árbol ø 15mm longitud árbol 25mm ø 115mm H 86mm distancia de sujeción 44mm dist. del agujero 145mm agujero ø 6mm tipo H35-700283		
Para modelos:	GFS1022, GFS2022		

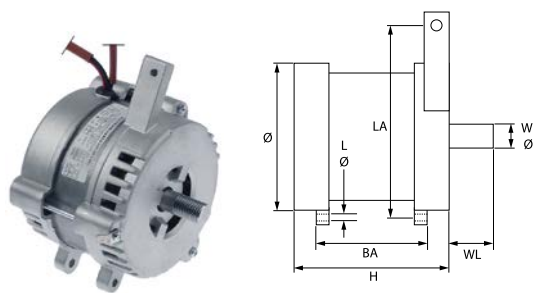

1

código	501434	referencia	00000000423
descripción	motor 230V fases 1 50Hz 1380rev/min árbol ø 15mm longitud árbol 33mm ø 113mm H 91mm distancia de sujeción 49mm dist. del agujero 150mm agujero ø 6mm tipo H40-423 ELETTRMECANICA condensador 8µF		
Para modelos:	GFS1025, GFS2025		

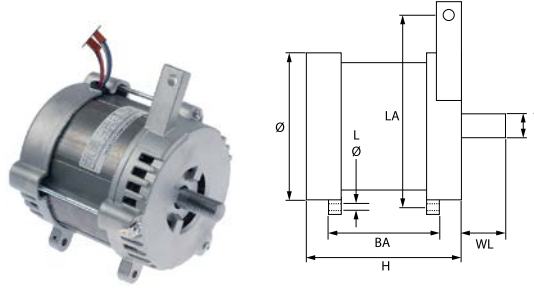

1

código	501433	referencia	00000000681
descripción	motor 230V fases 1 50Hz 1380rev/min árbol ø 15mm longitud árbol 35mm ø 113mm H 121mm distancia de sujeción 79mm dist. del agujero 150mm agujero ø 6mm tipo H70-681 ELETTRMECANICA condensador 10µF		
Para modelos:	GFS1030		

para mixers a inmersión

motores



1

código	698378	referencia	2847
descripción	motor para triturador portátil 230V 100W árbol ø 6.4mm GSM1000		
Para modelos:	GSM1000		

para exprimidores



código	501426	referencia	900956
descripción	motor para exprimidor 180W 230-240V 50Hz árbol ø 8mm longitud árbol 40mm tipo RCJ298252 0.18kW		
Para modelos:	GJU1001		

bombas de aumento de presión II

accesorios



código	365015	referencia	00000000633
descripción	condensador de servicio capacidad 10µF 400V tolerancia 5%Hz temperatura ambiente máx. -25 a + 85°C ø 35.5mm L 59mm M8 plástico empalme conector Faston 6,3mm protección		
Para modelos:	GFS1030, GFS2030		

bombas

bombas de lavado y aclarado

LGB



código	500984	referencia	902263
descripción	bomba entrada ø 45mm salida ø 39mm tipo ZF270VSX 230V 50Hz fases 1 0.4kW L 209mm dirección de rodadura derecho condensador 10µF LGB		
Para modelos:	GDW2001		



código	365012	referencia	00000000149
descripción	condensador de servicio capacidad 6.3µF 450V tolerancia 5% 50Hz temperatura ambiente máx. -25 a + 85°C ø 30mm L 61mm M8 plástico empalme conector Faston 6,3mm protección		
Para modelos:	GFS1022		

condensadores y filtros antiparasitarios

condensadores de servicio

plástico



código	365015	referencia	00000000633
descripción	condensador de servicio capacidad 10µF 400V tolerancia 5%Hz temperatura ambiente máx. -25 a + 85°C ø 35.5mm L 59mm M8 plástico empalme conector Faston 6,3mm protección		
Para modelos:	GFS1030, GFS2030		

bombas de salida

HANNING



código	501596	referencia	902332
descripción	bomba de desagüe 40W 220-240V entrada ø 30mm salida ø 24mm 50Hz tipo DPS35-061 HANNING		
Para modelos:	GDW2001		



1

código	365012	referencia	0000000149
descripción	condensador de servicio capacidad 6,3µF 450V tolerancia 5% 50Hz temperatura ambiente máx. -25 a + 85°C ø 30mm L 61mm M8 plástico empalme conector Faston 6,3mm protección		
Para modelos:	GFS1022		

condensadores de alta tensión



1

código	365159	referencia	253059000142
descripción	condensador de alta tensión para microondas 1.15µF tipo CH85-21115 2100V 50/60Hz doble empalme conector Faston 4,8mm L 105mm H 33mm An 52mm dependiente de aparato aluminio UE 1 pzs		
Para modelos:	GMW1025		



1

código	365013	referencia	0000000182
descripción	condensador de servicio capacidad 8µF 400V tolerancia 5%Hz temperatura ambiente máx. -25 a + 85°C ø 31.5mm L 55mm M8 plástico empalme conector Faston 6,3mm protección		
Para modelos:	GFS1025, GFS2019, GFS2022, GFS2025		

fusibles

fusibles finos



1

código	358186	referencia	DZJ020003
descripción	fusible medida ø6,3x32 15A retardado nominal 250V UE 1 pzs		
Para modelos:	GIC3035		

filtros

filtros antiparasitarios



1

código	365168	referencia	902107
descripción	filtro antiparasitario tipo FCP045000 250V 50/60Hz conductor 4 con T empalme conector Faston 6,3mm L 56mm ø 38mm Hmm Anmm M8 plástico UE 1 pzs		
Para modelos:	GDW2001		

accesorios eléctricos

cables

cables de alimentación aparatos



1

código	551085	referencia	00000009171 C03013
descripción	cable CEE7/7 tipo E+F 3 polos contactos P+N+T 1.5mm ² máx. 16A máx. 230V 2m con conector H05VV-F 3G1,5		
Para modelos:	GFS1022, GFS1025, GFS1030, GFS2019, GFS2022, GFS2025, GFS2030, GTO1001, GTO2001		

filtros de red

sin caja



1

código	403188	referencia	263029001088
descripción	filtro de red microondas para GMW1025 250V 50/60Hz conductor 2 placa electrónica empalme conector Faston 4,8mm L 80mm H 20mm An 40mm placa electrónica UE 1 pzs longitud del cable 120mm tipo DNV-0818A-5		
Para modelos:	GMW1025		



1

código	698880	referencia	E25EUB315300
descripción	cable de conexión 3 polos contactos P+N+T 1.5mm ² máx. 16A máx. 250V 2.9m		
Para modelos:	GDS2600, GPS2600, GSA2600, GSD2600, GSF2600		



1

código	699317	referencia	S900.47
descripción	cable de conexión CEE7/7 tipo E+F 3 polos contactos P+N+T 1.5mm ² máx. 16A máx. 250V 2.95m H05VV-F negro		
Para modelos:	GHS1600, GHS2600		



código	551203	referencia	C03007 CAV30014
descripción	cable de conexión CEE7/7 tipo E+F 3 polos contactos P+N+T 2.5mm ² máx. 16A máx. 230V 2m H07 RN-F con conector		
Para modelos:	GCO500, GEG2001		

código	551232	referencia	253159002607
descripción	cable de conexión par aparatos CEE7/7 1mm ² máx. 500V 1.5m UE 1 pzs empalme conector Faston 6,3mm negro		
Para modelos:	GMW1025		

código	551217	referencia	DQXA6002
descripción	cable de conexión par aparatos CEE7/7 tipo E+F 3 polos contactos P+N+T 0.75mm ² máx. 16A 2.2m con compensador de tracción 16A UE 1 pzs blanco		
Para modelos:	GBC1001, GBC1001S, GBC1001SS, GBC1002, GBC1002S, GBC1002SS, GBC1003, GBC1003S, GBC1003SS, GBC1102, GBC1103, GSC1100G, GSC2336		

código	551218	referencia	1.1.A.A08.02.02 1.1.A.A08.02.79 1.1.A.A08.02.87
descripción	cable de conexión par aparatos CEE7/7 tipo E+F 3 polos contactos P+N+T 0.75mm ² máx. 16A máx. 230V 2m UE 1 pzs gris		
Para modelos:	GCV1600, GGC1078, GGC1078B, GGC2270, GGC2270B		

código	552002	referencia	I3306470
descripción	cable de conexión par aparatos CEE7/7 tipo E+F contactos P+N+T 1mm ² máx. 16A máx. 230V 2.5m		
Para modelos:	GRE3600, GRE3600S		

código	551325	referencia	XC0000071R
descripción	cable de conexión par aparatos P+N+T 1mm ² máx. 500V 1.5m UE 1m empalme atornillado		
Para modelos:	GIC3035		

accesorios

pasacables

racores para cables

uniones roscadas

código	551379	referencia	PPC30004
descripción	racor para cables rosca PG13,5 ø cable 12mm montaje ø 20mm EC 24 plástico UE 1 pzs con tuerca		
Para modelos:	GCO500		

código	551288 ¹	referencia	A10032
descripción	racor para cables rosca PG16 ø cable 14mm montaje ø 22.5mm EC 27 plástico UE 1 pzs		
Para modelos:	GEG2001		

¹con tuerca de sujeción

código	506235	referencia	1.1.C.C24.03
descripción	compensador de tracción L 28mm An 12mm H 8mm agujero ø 3.5mm dist. del agujero 16mm plástico UE 1 pzs		
Para modelos:	GGC1078, GGC1078B		

código	694615	referencia	253169000472
descripción	mazo de cables para microondas L 800mm UE 1 pzs		
Para modelos:	GMW1025		



cables de enlace

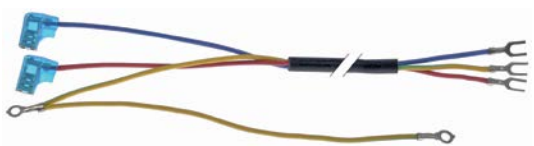

1

código	699304	referencia	DQXB9019
descripción	cable de enlace L 360mm 3 polos		
Para modelos:	GBC1001, GBC1001S, GBC1001SS, GBC1002, GBC1002S, GBC1002SS, GBC1003, GBC1003S, GBC1003SS, GBC1102, GBC1103		

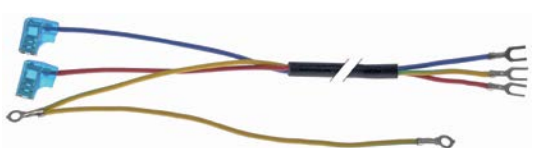

1

código	699305	referencia	DQXB2003
descripción	cable de enlace L 650mm 3 polos		
Para modelos:	GSC2336		

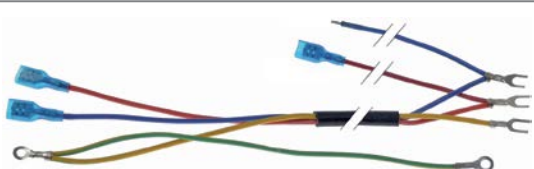

1

código	699306	referencia	DQXB4003
descripción	cable de enlace L 665mm 3 polos		
Para modelos:	GSC1100G		

terminales

regletas de bornes a tornillo/con contactos de enchufe



1

código	551444	referencia	01200720
descripción	borne de conexión 3 polos máx. 25A máx. 450V empalme conector Faston 6,3mm resis.a la temp. 150°C		
Para modelos:	GCO2001		



1

código	550516	referencia	MOR30005
descripción	borne de conexión 3 polos máx. 40A máx. 400V empalme M6/ conector Faston 6,3mm resis.a la temp. 150°C sección nominal 6mm ² distancia de sujeción 66,5mm		
Para modelos:	GCO500		



1

código	550411	referencia	904150 A16014
descripción	borne de conexión 6 polos máx. 40A máx. 450V empalme ø6mm ² / F6,3 resis.a la temp. 150°C sección nominal 6mm ²		
Para modelos:	GDW2001, GEG2001		

regletas de bornes con contactos de enchufe



1

código	519372	referencia	904167
descripción	borne de repartición 4 polos máx. 17.5A máx. 450V empalme F6,3 resis.a la temp. 110°C 450V		
Para modelos:	GDW2001		

enchufes para aparatos



1

código	550300	referencia	A10007
descripción	borne de conexión 3 polos contactos P+N+T		
Para modelos:	GTO1001, GTO2001		

cajas de bornes



1

código	551214	referencia	S900.48
descripción	caja de bornes 4 polos L 90mm An 52mm H 28mm con compensador de tracción UE 1 pzs		
Para modelos:	GHS1600, GHS2600		



1

código	551216	referencia	SLZB3001
descripción	caja de bornes 4 polos L 90mm An 52mm H 33mm con compensador de tracción 250V 1mm ² UE 1 pzs		
Para modelos:	GBC1001, GBC1001S, GBC1001SS, GBC1002, GBC1002S, GBC1002SS, GBC1003, GBC1003S, GBC1003SS, GBC1102, GBC1103, GSC2336		

componentes específicos
para cortadoras de fiambre

cubiertas



1

código	696528	referencia	00000000489
descripción	protector de cuchilla ø 180mm ø lama 220mm rosca de sujeción M6 medida de sujeción 12x12mm fundido aluminio edición en producción desde 2010		
Para modelos:	GFS1022, GFS2022		

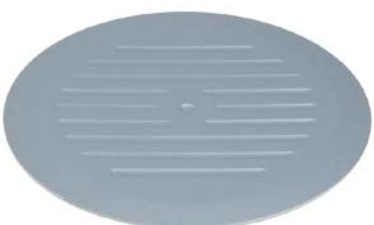

1

código	697749	referencia	00000000463 00000000490
descripción	protector de cuchilla ø 209mm ø lama 250mm rosca de sujeción M6 medida de sujeción 12x12mm aluminio		
Para modelos:	GFS1025, GFS2025		



1

código	697744	referencia	00000000403
descripción	protector de cuchilla ø 248mm ø lama 300mm rosca de sujeción M6 medida de sujeción 12x12mm aluminio		
Para modelos:	GFS1030, GFS2030		

tornillos de retención



1

código	698376	referencia	00000001302 00000701302
descripción	tornillo de retención rosca M6 L 134mm negro		
Para modelos:	GFS1022, GFS2022		

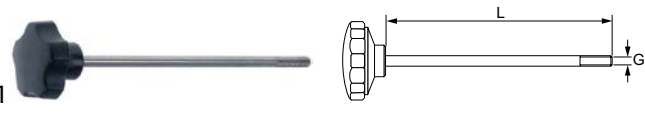

1

código	697439	referencia	00000000777
descripción	tornillo de retención rosca M6 L 155mm asidero ø 40mm		
Para modelos:	GFS2025		

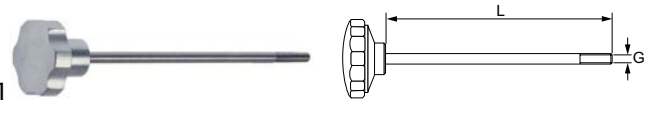

1

código	696602	referencia	00000009958
descripción	tornillo de retención rosca M6 L 188mm asidero ø 39mm para modelo 300/S-G, Dolly Verticale VS300		
Para modelos:	GFS1030		

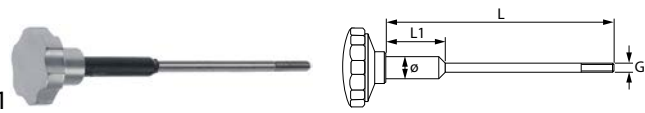

1

código	698629	referencia	00000709956
descripción	tornillo de retención rosca M6 L 155mm ø 10mm L1 55mm asidero ø 29mm		
Para modelos:	GFS1025		

manillas de ajuste



1

código	697419	referencia	00000000130 00000700130
descripción	manilla de ajuste 0-15 ø 55mm eje ø 12mm eje L 28mm asidero ø 42mm 250		
Para modelos:	GFS1022, GFS2019, GFS2022, GFS2025, GFS2030		



1

código	696522	referencia	00000009503
descripción	manilla de ajuste 0-22 ø 68mm eje ø 18mm eje L 50mm asidero ø 68mm sentido de rotación izquierdo		
Para modelos:	GFS1030		



excéntricas para espesor de corte



1

código	697470	referencia	00000000830
descripción	excéntrica para grosor de corte agujero ø 12mm ancho de estría 6mm ø ext. 52mm espesor 21.5mm		
Para modelos:	GFS2025		



1

código	697471	referencia	00000000379
descripción	excéntrica para grosor de corte agujero ø 12mm ancho de estría 6mm ø ext. 58mm espesor 21mm		
Para modelos:	GFS1022, GFS1025, GFS2019, GFS2022, GFS2030		

arandelas elásticas



1

código	697478	referencia	00000000671
descripción	arandela de muelle int.ø 19mm ø ext. 26mm UE 1 pzs		
Para modelos:	GFS1030		

piezas guía

para placas deslizantes



1

código	697483	referencia	00000000117
descripción	guía 195		
Para modelos:	GFS1022, GFS2019, GFS2022		



1

código	697448	referencia	00000009177
descripción	guía 220-250		
Para modelos:	GFS2025, GFS2030		



1

código	696524	referencia	00000000602 00000009691
descripción	guía L 117mm An 92mm H 51mm agujero ø 18mm soporte de eje ø 16mm aluminio		
Para modelos:	GFS1030		



1

código	697477	referencia	00000000126
descripción	placa de unión L 75mm An 15mm		
Para modelos:	GFS2019, GFS2022, GFS2025, GFS2030		

para carros



1

código	696510	referencia	00000009466
descripción	guía 220		
Para modelos:	GFS1022, GFS2019, GFS2022		

casquillos



1

código	698626	referencia	00000000119
descripción	casquillo ø ext. 18mm int.ø 16mm H 15mm		
Para modelos:	GFS1030, GFS2025, GFS2030		



1

código	698627	referencia	00000000611
descripción	casquillo ø ext. 8mm int.ø 5mm H 10mm		
Para modelos:	GFS1030		

árboles



código	697782	referencia	00000000501
descripción	árbol para carro ø 16mm L 390mm rosca M8		
Para modelos:	GFS1025		

carcasas

partes inferiores



código	698389	referencia	00000000768
descripción	cubierta L 447mm An 180mm plástico		
Para modelos:	GFS1030		



código	696512	referencia	00000000504
descripción	placa inferior 220		
Para modelos:	GFS1022, GFS2019, GFS2022		



código	696345	referencia	00000000516
descripción	placa inferior L 390mm An 190mm plástico 300		
Para modelos:	GFS1025		



código	698393	referencia	00000000701
descripción	placa inferior L 409mm An 174mm plástico		
Para modelos:	GFS2025, GFS2030		

protección de mano



código	697754	referencia	00000000784
descripción	protección de mano para cuchillo 300mm H 125mm An 60mm espesor 1.2mm agujero ø 6.5mm distancia de sujeción 84mm acero inoxidable		
Para modelos:	GFS1030		



código	696511	referencia	00000000197
descripción	rascador para cuchillo 220/250mm acero inoxidable		
Para modelos:	GFS1025, GFS2025		



código	697755	referencia	00000000162
descripción	protección de mano para carro 300 H 180mm An 152mm espesor 5mm agujero ø 10mm distancia de sujeción 110mm plástico		
Para modelos:	GFS1030		



código	697826	referencia	00000000924
descripción	protección de mano para cortadora de fiambre		
Para modelos:	GFS1025, GFS2025		



código	698964	referencia	00000000482
descripción	protección de mano para cortadora de fiambre 195-220		
Para modelos:	GFS2019, GFS2022		

accesorios



código	697482	referencia	00000000446
descripción	tornillo rosca M5 ø 8mm L 15mm		
Para modelos:	GFS1025, GFS1030, GFS2019, GFS2022, GFS2025		



			
1			
código	697481	referencia	0000000623
descripción	tornillo de cabeza moleteada rosca M6 rosca L 8mm ø 14mm H 6mm inox		
Para modelos:	GFS1030, GFS2019, GFS2022, GFS2025		

			
1			
código	698640	referencia	0000000924
descripción	portacuchillas completo con eje eje ø 14 longitud árbol 95mm rosca de sujeción M5 sujeción 3 orificios		
Para modelos:	GFS1022, GFS2022		



			
1			
código	697747	referencia	0000000920
descripción	portacuchillas con árbol D1 ø 40mm D2 ø 64.3mm D3 ø 67.5mm eje ø 14 L 33mm longitud árbol 152mm rosca de sujeción M5 fijación ø 3 orificios		
Para modelos:	GFS1025		

				
1				
código	697746	referencia	00000009469	
descripción	portacuchillas con árbol D1 ø 40mm D2 ø 76mm eje ø 16 L 40mm longitud árbol 157mm rosca de sujeción M5 fijación ø 3 orificios			
Para modelos:	GFS1030			
repuestos para	697746			
	código	514030	referencia	—
	anillo truarc árbol ø 20mm espesor 1.3mm acero DIN 471			
	código	523512	referencia	0000000632
	rodamiento de bolas radial tipo 6204-2RS árbol ø 20mm ø ext. 47mm An 14mm con arandelas de junta cojinete ranurado DIN 625-1			
	código	692029	referencia	—
	anillo truarc taladro ø 47mm espesor 1.8mm acero DIN 472			

recipientes			
manillas			
			
1			
código	698642	referencia	00000001130
descripción	manilla rosca M10 ø 59mm L 100mm aluminio		
Para modelos:	GFS1030		

				
1				
código	696515	referencia	00000001242	
descripción	manilla rosca M10x1,5 ø 34mm L 88mm prensador			
Para modelos:	GFS1025			
accesorios para	696515			
	código	696517	referencia	00000800678
	perno roscado para asidero ø 12mm L 64mm rosca M6/M10 acero inoxidable			

			
1			
código	697429	referencia	00000000298
descripción	manilla rosca M6 ø 25mm L 126mm con protección de mano D1 ø 70mm		
Para modelos:	GFS2019, GFS2022, GFS2025, GFS2030		

recipientes				
				
1				
código	698644	referencia	00000000608	
descripción	protector de mano para ralladora 300-350 L 290mm agujero ø 12mm manilla M10 CE			
Para modelos:	GFS1030			
accesorios para	698644			
	código	110703	referencia	—
	manilla cilíndrica rosca M10 ø 28mm L 87mm			



1

código	698418	referencia	00000009878
descripción	protector de mano para ralladora L 240mm agujero ø 12mm manilla M6 con asidero		
Para modelos:	GFS1025, GFS2025, GFS2030		

accesorios



1

código	697480	referencia	00000000151
descripción	perno de fijación prensador ø 7.5mm L 8mm plástico		
Para modelos:	GFS1025, GFS1030, GFS2019, GFS2022, GFS2025, GFS2030		



1

código	696517	referencia	00000800678
descripción	perno roscado para asidero ø 12mm L 64mm rosca M6/M10 acero inoxidable		
Para modelos:	GFS1025		
accesorios para	696517		
	código	696515	referencia 00000001242
	manilla rosca M10x1,5 ø 34mm L 88mm prensador		



1

código	698630	referencia	00000000827
descripción	punta prensador ø 3mm L 11.5mm		
Para modelos:	GFS1025, GFS1030, GFS2019, GFS2022, GFS2025, GFS2030		

cuchillas circulares estándar



1

código	697546	referencia	00000000254
descripción	cuchilla circular ø ext. 195mm soporte ø 30mm 3 orificios int. ø 155mm H 12.8mm C45 estándar		
Para modelos:	GFS2019		



1

código	697436	referencia	00000000855
descripción	cuchilla circular ø ext. 220mm soporte ø 40mm 3 orificios int. ø 180mm H 15.5mm C45		
Para modelos:	GFS1022, GFS2022		



1

código	697365	referencia	00000000142
descripción	cuchilla circular ø ext. 250mm soporte ø 40mm 3 orificios int. ø 210mm H 17.5mm C45 estándar		
Para modelos:	GFS1025, GFS2025		



1

código	697385	referencia	00000000636
descripción	cuchilla circular ø ext. 300mm soporte ø 40mm 3 orificios int. ø 250mm H 20mm C45 estándar		
Para modelos:	GFS1030, GFS2030		

unidades de afilado

tapa



1

código	696514	referencia	00000000863
descripción	tapa para afilador L 116mm An 100mm distancia de sujeción 26mm		
Para modelos:	GFS1025, GFS2022, GFS2025		



1

código	698643	referencia	00000000596
descripción	tapa para afilador L 150mm An 120mm		
Para modelos:	GFS1030, GFS2030		



soportes			
			
1			
código	696493	referencia	00000000771
descripción	soporte para afilador L 60mm An 31mm H 78mm agujero ø 12mm rosca de sujeción M6 con escuadra de sujeción		
Para modelos:	GFS1030		

pomos			
			
1			
código	697445	referencia	00000000677
descripción	pomo seta rosca M6 asidero ø 33mm L 26mm plástico negro		
Para modelos:	GFS2030		

			
1			
código	697441	referencia	00000000854
descripción	tornillo de retención rosca M5 asidero ø 25mm negro L 30mm		
Para modelos:	GFS2022, GFS2025		

			
1			
código	696518	referencia	00000009954
descripción	tornillo de retención rosca M5 L 47mm asidero ø 25mm plata		
Para modelos:	GFS1025		

			
1			
código	697428	referencia	00000000138
descripción	tornillo de retención rosca M6 asidero ø 25mm negro L 15mm		
Para modelos:	GFS2019		

			
1			
código	697384	referencia	00000000734
descripción	tornillo de retención rosca M6 asidero ø 25mm negro L 54mm		
Para modelos:	GFS2030		

			
1			
código	696523	referencia	00000009510
descripción	tornillo de retención rosca M6 L 53mm asidero ø 34mm plata		
Para modelos:	GFS1030		

unidades de afilado			
			
1			
código	697420	referencia	00000009168
descripción	unidad de afilado 195/200/220/250		
Para modelos:	GFS2019		
repuestos para	697420		
		código	697423
		referencia	00000000816
	piedra de afilar ø 40mm espesor 8mm taladro ø 6mm granulación fino con bisel, con cubo		
		código	697424
		referencia	00000000871
	piedra de afilar ø 40mm espesor 8mm taladro ø 6mm granulación grueso con bisel, con cubo		
		código	697428
		referencia	00000000138
	tornillo de retención rosca M6 asidero ø 25mm negro L 15mm		

			
1			
código	697397	referencia	00000009864
descripción	unidad de afilado 220/250/275		
Para modelos:	GFS1022, GFS1025, GFS2022, GFS2025		

			
1			
código	697355	referencia	00000009693
descripción	unidad de afilado 350		
Para modelos:	GFS1030		
repuestos para	697355		
	código	697377	referencia 00000000720
	piedra de afilar ø 51mm espesor 12mm taladro ø 8mm granulación grueso sin bisel		
	código	697378	referencia 00000000721
	piedra de afilar ø 51mm espesor 7mm taladro ø 8mm granulación fino con bisel, sin cubo		

árboles			
			
1			
código	698633	referencia	00000000778
descripción	árbol para afilador ø 12mm L 95mm rosca M5		
Para modelos:	GFS1030		

piedras de afilar			
			
1			
código	697378	referencia	00000000721
descripción	piedra de afilar ø 51mm espesor 7mm taladro ø 8mm granulación fino con bisel, sin cubo		
Para modelos:	GFS1030, GFS2030		

piedras de afilar con cubo			
			
1			
código	697423	referencia	00000000816
descripción	piedra de afilar ø 40mm espesor 8mm taladro ø 6mm granulación fino con bisel, con cubo		
Para modelos:	GFS2019		

			
1			
código	697424	referencia	00000000871
descripción	piedra de afilar ø 40mm espesor 8mm taladro ø 6mm granulación grueso con bisel, con cubo		
Para modelos:	GFS2019		

			
1			
código	697422	referencia	00000000642
descripción	piedra de afilar ø 45mm espesor 8mm taladro ø 6mm granulación fino con bisel, con cubo		
Para modelos:	GFS1025, GFS2022, GFS2025		

			
1			
código	697421	referencia	00000000641
descripción	piedra de afilar ø 45mm espesor 8mm taladro ø 6mm granulación grueso con bisel, con cubo		
Para modelos:	GFS1025, GFS2022, GFS2025		

piedras afilar en forma de taza			
			
1			
código	697377	referencia	00000000720
descripción	piedra de afilar ø 51mm espesor 12mm taladro ø 8mm granulación grueso sin bisel		
Para modelos:	GFS1030, GFS2030		

carros cortadora			
manillas			
			
1			
código	697440	referencia	00000000432
descripción	manilla rosca M10 asidero ø 66mm H 51mm negro		
Para modelos:	GFS1022		

accesorios			
			
1			
código	698631	referencia	00000000895
descripción	árbol para carro rosca M6 L 170mm ø 12mm		
Para modelos:	GFS2025		



			
1			
código	697827	referencia	0000000678
descripción	árbol para cortadora de fiambre rosca M10 L 95mm rosca L 12/15mm longitud total 122mm ø 16mm acero inoxidable		
Para modelos:	GFS1030		

			
1			
código	696516	referencia	0000000186
descripción	soporte para carro L 56mm aluminio		
Para modelos:	GFS2019, GFS2022		

otros			
			
1			
código	697476	referencia	0000000509
descripción	casquillo ø 14mm L 88mm int.ø 12mm		
Para modelos:	GFS1025, GFS2019, GFS2022, GFS2025, GFS2030		

			
1			
código	698628	referencia	0000000774
descripción	perno roscado rosca M6 L 37mm para cortadora de fiambre		
Para modelos:	GFS1030		

			
1			
código	698392	referencia	0000000828
descripción	perno roscado rosca M6 ø 6mm L 35mm para cortadora de fiambre		
Para modelos:	GFS1025, GFS1030, GFS2019, GFS2022, GFS2025, GFS2030		

			
1			
código	698388	referencia	0000000765
descripción	pletina sujeción ø 18mm L 128mm An 28mm		
Para modelos:	GFS1030		

			
1			
código	697356	referencia	0000000300
descripción	soporte rosca M10x0,75 ø 30mm para microinterruptor int.ø 14.5mm espesor 13mm rosca de sujeción M5		
Para modelos:	GFS1025		

para mixers a inmersión

carcasas

			
1			
código	698387	referencia	2853M
descripción	adhesivo para tapa plata L 50mm An 27mm		
Para modelos:	GSM1000		

			
1			
código	698386	referencia	2848M
descripción	adhesivo para triturador portátil plata L 125mm An 25mm espesor 1mm CON.-DESC.		
Para modelos:	GSM1000		

			
1			
código	699133	referencia	2843M
descripción	caja derecho azul GSM1000		
Para modelos:	GSM1000		
accesorios para	699133		
	código	699134	referencia
			2849M
	caja izquierdo azul GSM1000		



1

código	699134	referencia	2849M
descripción	caja izquierdo azul GSM1000		
Para modelos:	GSM1000		
accesorios para	699134		
	código	referencia	2843M
	caja derecho azul GSM1000		



1

código	699708	referencia	2840M
descripción	cubierta para asidero azul GSM1000 L 80mm An 42mm		
Para modelos:	GSM1000		



1

código	696503	referencia	2851
descripción	manilla para triturador portátil plástico gris		
Para modelos:	GSM1000		

acoplamiento



1

código	696505	referencia	2860
descripción	acoplamiento con pasador elástico para triturador portátil D1 ø 19mm ø int. 1 8mm dientes 8 GSM1000		
Para modelos:	GSM1000		



1

código	696504	referencia	2846
descripción	acoplamiento para triturador portátil D1 ø 19mm ø int. 1 6.3mm L 29.5mm dientes 8 GSM1000		
Para modelos:	GSM1000		

mezcladoras
cuchillas
cuchillas con soportes



1

código	698262	referencia	0551
descripción	cuchillo ø 39mm agujero ø 4mm H 12mm		
Para modelos:	GSM1000		



1

código	698261	referencia	0550
descripción	cuchillo ø 39mm agujero ø 4mm H 18mm		
Para modelos:	GSM1000		



1

código	698381	referencia	0552
descripción	disco mezclador ø 36mm agujero ø 4mm H 0.8mm GSM1000		
Para modelos:	GSM1000		



1

código	698382	referencia	0553
descripción	disco mezclador ø 36mm agujero ø 4mm H 3.4mm GSM1000		
Para modelos:	GSM1000		





mezcladoras

 <p>1</p>			
código	698379	referencia	2845M
descripción	varilla mezcladora GSM1000 L 234mm brida ø 66mm		
Para modelos:	GSM1000		

 <p>1</p>			
código	696507	referencia	2854
descripción	soporte para motor plástico negro		
Para modelos:	GSM1000		

árboles

 <p>1</p>											
código	698380	referencia	2844M								
descripción	árbol de accionamiento para triturador portátil con acoplamiento D1 ø 4mm D2 ø 8mm L 214mm inox										
Para modelos:	GSM1000										
repuestos para	698380										
 <table border="1"> <tr> <td>código</td> <td>696505</td> <td>referencia</td> <td>2860</td> </tr> <tr> <td>descripción</td> <td colspan="3">acoplamiento con pasador elástico para triturador portátil D1 ø 19mm ø int. 1 8mm dientes 8 GSM1000</td> </tr> </table>				código	696505	referencia	2860	descripción	acoplamiento con pasador elástico para triturador portátil D1 ø 19mm ø int. 1 8mm dientes 8 GSM1000		
código	696505	referencia	2860								
descripción	acoplamiento con pasador elástico para triturador portátil D1 ø 19mm ø int. 1 8mm dientes 8 GSM1000										

 <p>1</p>			
código	698385	referencia	2841
descripción	sporte para asa L 40mm An 37mm espesor 1.5mm		
Para modelos:	GSM1000		

otros

 <p>1</p>			
código	698383	referencia	0632
descripción	junta de árbol int.ø 4mm ø ext. 12mm para triturador portátil H 6.3mm		
Para modelos:	GSM1000		

 <p>1</p>			
código	698384	referencia	45710
descripción	tapa de protección para asa plástico negro		
Para modelos:	GSM1000		

para exprimidores

bandejas colectoras

 <p>1</p>			
código	696502	referencia	900963
descripción	bandeja colector para exprimidor ø 175mm agujero ø 42mm H 110mm inox		
Para modelos:	GJU1001		

 <p>1</p>			
código	532648	referencia	2859
descripción	junta tórica EPDM espesor 1.5mm int.ø 5mm UE 1 pzs		
Para modelos:	GSM1000		

juntas

 <p>1</p>			
código	696506	referencia	2858
descripción	pomo para placa electrónica ø 26mm negro UE 1 pzs		
Para modelos:	GSM1000		

 <p>1</p>			
código	511953	referencia	900871
descripción	juego de juntas para exprimidor		
Para modelos:	GJU1001		



1

código	532647	referencia	900970
descripción	junta tórica EPDM espesor 1.8mm int.ø 11.8mm UE 1 pzs		
Para modelos:	GJU1001		

motores



1

código	501426	referencia	900956
descripción	motor para exprimidor 180W 230-240V 50Hz árbol ø 8mm longitud árbol 40mm tipo RCJ298252 0.18kW		
Para modelos:	GJU1001		

elementos exprimidores



1

código	650167	referencia	221266
descripción	complemento exprimidor juego para exprimidor ø 57/62/79mm H 45/50/55mm plástico		
Para modelos:	GJU1001		



1

código	650168	referencia	900901
descripción	filtro para exprimidor ø 155mm H 23mm plástico		
Para modelos:	GJU1001		

árboles



1

código	650170	referencia	900895
descripción	árbol L 48mm cuadrado rosca M8x1,25 para exprimidor EC 12		
Para modelos:	GJU1001		

otros



1

código	650169	referencia	221242
descripción	bandeja de goteo para exprimidor ø 79mm H 20mm plástico negro		
Para modelos:	GJU1001		



1

código	650171	referencia	900925
descripción	cubierta para árbol ø 44mm H 18mm aluminio		
Para modelos:	GJU1001		

para frigoríficos

sistemas de desagüe

válvulas de desagüe



1

código	699499	referencia	W0409858
descripción	pileta de desagüe empalme A L 47mm tubo ø 15mm para GFR2700/GRE2700 plástico		
Para modelos:	GFR2700, GRE2700		

accesorios para 699499



código	699567	referencia	W0409859
descripción	pileta de desagüe empalme B L 20mm para GFR2700/GRE2700 plástico		



1

código	699567	referencia	W0409859
descripción	pileta de desagüe empalme B L 20mm para GFR2700/GRE2700 plástico		
Para modelos:	GFR2700, GRE2700		

accesorios para 699567



código	699499	referencia	W0409858
descripción	pileta de desagüe empalme A L 47mm tubo ø 15mm para GFR2700/GRE2700 plástico		



cubetas de desagüe



1

código	530916	referencia	80012001
descripción	cubeta de desagüe L 520mm An 233mm H 30mm para GFR2700/GRE2700 agujero ø 24mm		
Para modelos:	GFR2700, GRE2700		

elementos de manejo



1

código	698848	referencia	GPC1088-03
descripción	lámpara con termostato ø 140mm H 35mm		
Para modelos:	GPC1088		

recambios y accesorios



1

código	699232	referencia	I0535012
descripción	compensador de tracción L 56mm An 14.5mm H 20mm		
Para modelos:	GFR3600S		



1

código	694967	referencia	SLCX0002
descripción	cubierta L 51mm An 44mm H 12mm plástico distancia de sujeción 30mm		
Para modelos:	GSC2336		



1

código	692867	referencia	W04102051	
descripción	cubierta ø 20mm L 400mm An 43mm plástico UE 1 pzs para GFR2700/GRE2700			
Para modelos:	GFR2700, GRE2700			
accesorios para	692867			
	código	692870	referencia	W0413062
	descripción	tope de goma L 40mm An 17mm H 30mm para GFR2700/GRE2700		
	código	696789	referencia	W0210413
	descripción	tubo de cobre con aislamiento diámetro ø 6 para frigorífico GFR2700/GRE2700		



1

código	698878	referencia	WJQZ9001
descripción	guía contrapeso para puerta corredera L 248mm An 20mm H 10mm		
Para modelos:	GBC1102, GBC1103		



1

código	699568	referencia	W0604038
descripción	placa de asiento para bisagra de puerta batiente pos. de montaje abajo L 35mm An 25mm para GFR2700/GRE2700		
Para modelos:	GFR2700, GRE2700		



1

código	699569	referencia	W0604030
descripción	placa de asiento para bisagra de puerta batiente pos. de montaje derecho L 74mm An 42mm para GFR2700/GRE2700		
Para modelos:	GFR2700, GRE2700		



1

código	698849	referencia	GPC1046-03 GPC1088-04
descripción	tapa L 96mm An 44mm H 13mm plástico		
Para modelos:	GPC1046, GPC1088		



1

código	692870	referencia	W0413062
descripción	tope de goma L 40mm An 17mm H 30mm para GFR2700/GRE2700		
Para modelos:	GFR2700, GRE2700		
accesorios para	692870		
	código	692867	referencia W04102051
	cubierta ø 20mm L 400mm An 43mm plástico UE 1 pzs para GFR2700/GRE2700		
	código	696789	referencia W0210413
	tubo de cobre con aislamiento diámetro ø 6 para frigorífico GFR2700/GRE2700		

cajas y paneles frontales

cubiertas



1

código	699574	referencia	81131204
descripción	cubierta anterior para evaporador L 598mm An 295mm H 65mm para GFR2700/GRE2700		
Para modelos:	GFR2700, GRE2700		
accesorios para	699574		
	código	699577	referencia 80021203
	cubierta izquierdo para evaporador L 255mm An 155mm H 15mm para GFR2700/GRE2700		
	código	699578	referencia 80021204
	cubierta derecho para evaporador L 255mm An 155mm H 15mm para GFR2700/GRE2700		





1

código	699578	referencia	80021204
descripción	cubierta derecho para evaporador L 255mm An 155mm H 15mm para GFR2700/GRE2700		
Para modelos:	GFR2700, GRE2700		
accesorios para	699578		
	código	699574	referencia 81131204
	cubierta anterior para evaporador L 598mm An 295mm H 65mm para GFR2700/GRE2700		
	código	699577	referencia 80021203
	cubierta izquierdo para evaporador L 255mm An 155mm H 15mm para GFR2700/GRE2700		



1

código	699577	referencia	80021203
descripción	cubierta izquierdo para evaporador L 255mm An 155mm H 15mm para GFR2700/GRE2700		
Para modelos:	GFR2700, GRE2700		
accesorios para	699577		
	código	699574	referencia 81131204
	cubierta anterior para evaporador L 598mm An 295mm H 65mm para GFR2700/GRE2700		
	código	699578	referencia 80021204
	cubierta derecho para evaporador L 255mm An 155mm H 15mm para GFR2700/GRE2700		



1

código	699576	referencia	81131203
descripción	cubierta para cubeta desagüe L 598mm An 218mm H 42mm para GFR2700/GRE2700		
Para modelos:	GFR2700, GRE2700		
accesorios para	699576		
	código	696783	referencia W0803011
	aislamiento Styropor para cubeta desagüe L 515mm An 213mm H 18mm UE pzs para GFR2700/GRE2700		



1

código	692879	referencia	W0409863
descripción	cubierta para lámpara L 185mm An 55mm H 40mm para GFR2700/GRE2700		
Para modelos:	GFR2700, GRE2700		
accesorios para	692879		
	código	357260	referencia W0304086 W0304511
	barra de LED L 130mm An 14mm H 8mm longitud del cable 300mm GFR2700/GRE2700		



1

código	998252	referencia	44037000
descripción	cubierta para ventilación L 72mm An 62mm H 10mm UE 1 pzs		
Para modelos:	GFR3600S, GRE3600, GRE3600S		



1



código	699573	referencia	80010942 80011042
descripción	deflector atrás L 1030mm An 363mm H 20mm para GFR2700/GRE2700		
Para modelos:	GFR2700, GRE2700		
accesorios para	699573		
	código	referencia	80010941 80011041
	soporte para chapa de guía L 800mm An 38mm H 20mm para GFR2700/GRE2700 3 orificios		

1



código	699586	referencia	80010941 80011041
descripción	soporte para chapa de guía L 800mm An 38mm H 20mm para GFR2700/GRE2700 3 orificios		
Para modelos:	GFR2700, GRE2700		
accesorios para	699586		
	código	referencia	80010942 80011042
	deflector atrás L 1030mm An 363mm H 20mm para GFR2700/GRE2700		

paneles de mando

1



código	699234	referencia	44027000
descripción	revestimiento L 780mm An 67mm H 62mm pos. de montaje arriba		
Para modelos:	GRE3600		

tapa

1



código	698864	referencia	GPC1046-05 GPC1088-06
descripción	cubierta negro L 50mm An 42mm H 7mm		
Para modelos:	GPC1046, GPC1088		

carcasas

1



código	699233	referencia	I9500323
descripción	caja de bornes L 98mm An 74mm H 35mm Kit		
Para modelos:	GFR3600S, GRE3600, GRE3600S		

1



código	699575	referencia	81131401 81131403
descripción	panel frontal para frigorífico L 730mm An 300mm H 62mm para GFR2700/GRE2700		
Para modelos:	GFR2700, GRE2700		

pies para aparatos

1



código	698865	referencia	GPC1088-12
descripción	pie de aparato M8 rosca L 15mm ø 29mm		
Para modelos:	GPC1088		

manillas

1



código	692390	referencia	LCCG0005
descripción	barra de asidero para puerta L 380mm An 40mm aluminio UE 1 pzs		
Para modelos:	GSC1100G		

tapas





código	692372	referencia	S900.03
descripción	tapa gris ø 16.5mm montaje ø 12.5mm H 7mm UE 1 pzs		
Para modelos:	GHS1600, GHS2600		

marcos

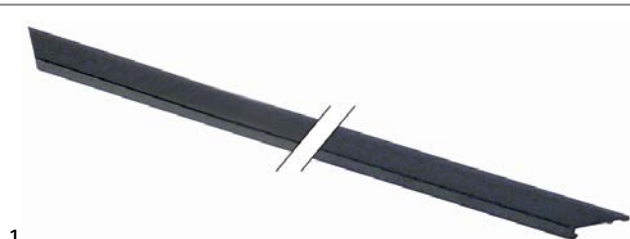

código	699584	referencia	W04102044
descripción	marco para puerta pos. de montaje arriba/abajo L 650mm An 19mm H 7.5mm plástico para GFR2700/GRE2700		
Para modelos:	GFR2700, GRE2700		
accesorios para	699584		
	código	referencia	W04102045
	marco para puerta pos. de montaje izquierdo/derecho L 1530mm An 19mm H 7.5mm plástico para GFR2700/GRE2700		



código	699583	referencia	W04102045
descripción	marco para puerta pos. de montaje izquierdo/derecho L 1530mm An 19mm H 7.5mm plástico para GFR2700/GRE2700		
Para modelos:	GFR2700, GRE2700		
accesorios para	699583		
	código	referencia	W04102044
	marco para puerta pos. de montaje arriba/abajo L 650mm An 19mm H 7.5mm plástico para GFR2700/GRE2700		

otros





código	692391	referencia	SLZE0027
descripción	caja para portalámparas L 150mm An 40mm H 20mm plástico UE 1 pzs		
Para modelos:	GSC1100G, GSC2336		

código	692392	referencia	SLSE4005
descripción	cubierta para iluminación An 1170mm H 280mm espesor 1mm plástico UE 1 pzs		
Para modelos:	GSC1100G		

puertas

puertas



código	699571	referencia	81130201
descripción	puerta derecho apto para GFR2700/GRE2700 An 730mm H 1610mm espesor 45mm acero inoxidable		
Para modelos:	GFR2700, GRE2700		
repuestos para	699571		
	código	referencia	W0604030
	placa de asiento para bisagra de puerta batiente pos. de montaje derecho L 74mm An 42mm para GFR2700/GRE2700		
	código	referencia	W0409842
	casquillo arriba para bisagra de puerta batiente int.ø 11mm ø ext. 13mm L 29.5mm para GFR2700/GRE2700		
	código	referencia	W0409843
	casquillo abajo para bisagra de puerta batiente int.ø 11mm ø ext. 13mm L 26mm para GFR2700/GRE2700		
	código	referencia	W0404514
	junta para frigorífico perfil 9750 An 660mm L 1537mm medida inserción		



código	699382	referencia	BLGM4011
descripción	puerta cristal derecho An 600mm H 1330mm P 40mm		
Para modelos:	GSC1100G		
repuestos para	699382		
	código	901662	referencia SLJP4007
	junta de puerta perfil 9156 An 569mm L 1295mm medida inserción UE 1 pzs		



código	699381	referencia	BLGM4010
descripción	puerta cristal izquierdo An 600mm H 1330mm P 40mm		
Para modelos:	GSC1100G		
repuestos para	699381		
	código	901662	referencia SLJP4007
	junta de puerta perfil 9156 An 569mm L 1295mm medida inserción UE 1 pzs		

otros



1

código	696783	referencia	W0803011
descripción	aislamiento Styropor para cubeta desagüe L 515mm An 213mm H 18mm UE pzs para GFR2700/GRE2700		
Para modelos:	GFR2700, GRE2700		
accesorios para	696783		

	código	699576	referencia 81131203
	cubierta para cubeta desagüe L 598mm An 218mm H 42mm para GFR2700/GRE2700		



1

código	692869	referencia	81131801 W0409081
descripción	cubierta para tubo de desagüe L 145mm An 49mm H 44mm plástico para GFR2700		
Para modelos:	GFR2700, GRE2700		



1

código	698888	referencia	SLZV0019
descripción	cubierta transparente para lámpara L 810mm An 40mm H 30mm UE 1 pzs		
Para modelos:	GBC1003, GBC1003S, GBC1003SS, GBC1103		

			
1			
código	692426	referencia	LCCJ2029
descripción	guida para frigorífico L 1145mm An 26mm H 4.5mm UE 1 pzs		
Para modelos:	GSC1100G, GSC2336		

			
1			
código	692401	referencia	1.1.C.C23.01
descripción	pomo ø 27mm gris marca cero eje ø 6x4,6mm parte plana izquierdo para termostato para apretar UE 1		
Para modelos:	GGC1078, GGC1078B		

			
1			
código	698877	referencia	LCCK0001
descripción	soporte de bandeja L 26.5mm An 8.5mm H 40mm aluminio		
Para modelos:	GSC1100G, GSC2336		

recambios y accesorios

			
1			
código	699422	referencia	1.1.C.C63.61
descripción	clip para deshidratador L 90mm An 20mm H 52mm plástico UE 1 pzs		
Para modelos:	GCV1600		

para vitrinas frías

elementos de manejo

			
1			
código	692402	referencia	1.1.C.C12.14
descripción	manilla gris para vitrina H 9.5mm L 85mm An 25mm distancia de sujeción 70mm UE 1 pzs		
Para modelos:	GGC1078		

cajas y paneles frontales

paneles

			
1			
código	692417	referencia	1.1.C.C21.01
descripción	caja para distribución An 130mm P 75mm H 145mm plástico UE 1 pzs		
Para modelos:	GGC1078, GGC1078B		

			
1			
código	692409	referencia	1.1.C.C12.06
descripción	manilla de puerta L 100mm An 32mm dist. del agujero 68mm blanco		
Para modelos:	GGC2270		

			
1			
código	699407	referencia	S24AC20A0005
descripción	chapa pos. de montaje arriba para puerta An 890mm P 115mm H 10mm		
Para modelos:	GDS2600, GPS2600, GSA2600, GSD2600, GSF2600		

			
1			
código	692700	referencia	1.1.C.C12.07
descripción	manilla de puerta L 100mm An 32mm dist. del agujero 68mm negro UE 1 pzs		
Para modelos:	GGC2270B		

			
1			
código	699414	referencia	1.1.C.C02.01
descripción	cubierta de lampara An 310mm P 5mm H 172mm blanco		
Para modelos:	GGC2270		



			
1			
código	699415	referencia	1.1.C.C02.02
descripción	cubierta de lampara An 310mm P 5mm H 172mm negro		
Para modelos:	GGC1078, GGC1078B, GGC2270B		

			
1			
código	692405	referencia	1.1.C.C22.08
descripción	panel de mando para vitrina temperatura MIN/MAX An 130mm P 23mm H 145mm plástico UE 1 pzs		
Para modelos:	GGC1078, GGC1078B		

			
1			
código	699409	referencia	1.1.C.C15.03.03
descripción	panel frontal pos. de montaje anterior An 518mm P 35mm H 440mm blanco		
Para modelos:	GGC2270		

			
1			
código	699410	referencia	1.1.C.C15.03.35
descripción	panel frontal pos. de montaje anterior An 518mm P 35mm H 440mm negro		
Para modelos:	GGC2270B		

			
1			
código	699401	referencia	S24AC21A0001
descripción	panel frontal pos. de montaje anterior An 865mm P 15mm H 248mm		
Para modelos:	GDS2600, GPS2600, GSA2600, GSD2600, GSF2600		

			
1			
código	698854	referencia	1.1.C.C15.01.02
descripción	panel frontal pos. de montaje anterior/posterior negro An 427mm P 33mm H 190mm plástico UE 1 pzs para vitrina		
Para modelos:	GGC1078B		

			
1			
código	692411	referencia	1.1.C.C40.02
descripción	placa de asiento para evaporador L 305mm An 241mm espesor 1.5mm plástico UE 1 pzs		
Para modelos:	GGC2270, GGC2270B		

<h3>tapa</h3>			
			
1			
código	699403	referencia	S24AC50A0003
descripción	pieza adicional para vitrinas frías An 910mm P 705mm H 125mm		
Para modelos:	GSD2600		

			
1			
código	699404	referencia	S24AC30A0003
descripción	pieza adicional para vitrinas frías An 910mm P 705mm H 55mm		
Para modelos:	GDS2600, GSF2600		

<h3>carcasas</h3>			
			
1			
código	692436	referencia	1.1.C.C21.03
descripción	caja An 128mm P 65mm H 38mm plástico UE 1 pzs		
Para modelos:	GGC2270, GGC2270B		



1

código	692415	referencia	1.1.C.C18.04
descripción	caja para evaporador An 370mm H 175mm L 420mm UE 1 pzs		
Para modelos:	GGC1078, GGC1078B		



1

código	699323	referencia	VRX1560.2
descripción	caja para interruptor An 114mm P 68mm H 100mm		
Para modelos:	GHS1600, GHS2600		



1

código	699175	referencia	P04AC21A0003
descripción	caja para parte de manejo An 200mm P 115mm H 95mm		
Para modelos:	GDS2600, GPS2600, GSA2600, GSD2600, GSF2600		



1

código	692420	referencia	1.1.B.B05.02
descripción	cubierta para condensador An 365mm P 220mm H 130mm chapa UE 1 pzs		
Para modelos:	GGC1078, GGC1078B		



1

código	692422	referencia	1.1.C.C16.02
descripción	cubierta para evaporador An 280mm P 345mm H 35mm plástico UE 1 pzs		
Para modelos:	GGC1078, GGC1078B		

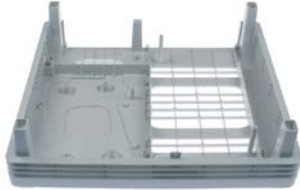

1

código	692416	referencia	1.1.C.C25.15
descripción	fondo para vitrina An 378mm H 115mm L 425mm UE 1 pzs		
Para modelos:	GGC1078		



1

código	698860	referencia	1.1.C.C56.84
descripción	guía pos. de montaje anterior para parte lateral An 23mm P 30mm H 635mm UE 1 pzs		
Para modelos:	GGC1078B		



1

código	698861	referencia	1.1.C.C56.85
descripción	guía pos. de montaje atrás para parte lateral An 30mm P 30mm H 635mm UE 1 pzs		
Para modelos:	GGC1078B		



1

código	692403	referencia	1.1.C.C15.01.01
descripción	panel frontal pos. de montaje anterior para vitrina An 427mm P 33mm H 190mm plástico UE 1 pzs blanco		
Para modelos:	GGC1078		



1

código	692269	referencia	1.1.C.C15.01.05
descripción	pared posterior para vitrina An 515mm P 45mm H 410mm blanco		
Para modelos:	GGC2270		





1

código	698851	referencia	1.1.C.C15.01.06
descripción	pared posterior para vitrina An 515mm P 45mm H 410mm negro		
Para modelos:	GGC2270B		



1

código	692270	referencia	1.1.C.C15.03.08 1.1.C.C15.03.09
descripción	parte lateral An 418mm H 410mm plástico blanco		
Para modelos:	GGC2270		



1

código	692437	referencia	1.1.C.C22.07
descripción	tapa de caja An 130mm P 70mm H 6mm plástico UE 1 pzs		
Para modelos:	GGC2270, GGC2270B		



1

código	692419	referencia	1.1.C.C01.15
descripción	tapa de caja para vitrinas frías An 425mm L 380mm plástico UE 1 pzs blanco		
Para modelos:	GGC1078		
accesorios para	692419		
	código	692414	referencia
			—
	 tapa L 313mm An 163mm para iluminación UE 1 pzs		

regillas de ventilación



1

código	699411	referencia	1.1.C.C14.01
descripción	cubierta para ventilador An 425mm P 380mm H 36mm plástico UE 1 pzs blanco		
Para modelos:	GGC1078		



1

código	698855	referencia	1.1.C.C14.02
descripción	cubierta para ventilador An 425mm P 380mm H 36mm plástico UE 1 pzs negro		
Para modelos:	GGC1078B		



1

código	699417	referencia	1.1.C.C26.01
descripción	rejilla pos. de montaje abajo para ventilación An 350mm P 12mm H 57mm plástico UE 1 pzs blanco		
Para modelos:	GGC1078		



1

código	698853	referencia	1.1.C.C26.02
descripción	rejilla pos. de montaje abajo para ventilación An 350mm P 12mm H 57mm plástico UE 1 pzs negro		
Para modelos:	GGC1078B		



1

código	701254	referencia	1.1.C.C49.10
descripción	rejilla de ventilación para aspiración plástico negro H 50mm L 260mm UE 1 pzs		
Para modelos:	GCV1600		



1

código	701253	referencia	1.1.C.C49.09
descripción	rejilla de ventilación para ventilador plástico negro H 50mm L 620mm UE 1 pzs		
Para modelos:	GCV1600		

marcos



1

código	699413	referencia	1.1.C.C63.13
descripción	marco de puerta exterior An 375mm P 10mm H 375mm		
Para modelos:	GCV1600		

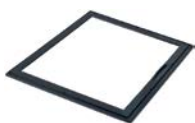

1

código	699412	referencia	1.1.C.C63.14
descripción	marco de puerta interior An 378mm P 10mm H 385mm		
Para modelos:	GCV1600		

partes laterales



1

código	699324	referencia	VRX38.12
descripción	parte lateral An 390mm P 40mm H 222mm		
Para modelos:	GHS1600, GHS2600		



1

código	698850	referencia	1.1.C.C15.03.10
descripción	parte lateral An 418mm H 410mm plástico negro		
Para modelos:	GGC2270B		



1

código	698862	referencia	1.1.C.C38.19
descripción	parte lateral para puerta L 590mm espesor 17mm		
Para modelos:	GGC1078B		



1

código	692404	referencia	1.1.C.C15.02.01
descripción	parte lateral pos. de montaje izquierdo/derecho blanco An 316mm P 13.5mm H 190mm plástico UE 1 pzs para vitrina		
Para modelos:	GGC1078		



1

código	698852	referencia	1.1.C.C15.02.02
descripción	parte lateral pos. de montaje izquierdo/derecho negro An 316mm P 13.5mm H 190mm plástico UE 1 pzs para vitrina		
Para modelos:	GGC1078B		



1

código	699443	referencia	1.1.C.C56.03
descripción	parte lateral pos. de montaje vertical An 40mm P 40mm H 1370mm blanco		
Para modelos:	GGC2270		



			
1			
código	699444	referencia	1.1.C.C56.06
descripción	parte lateral pos. de montaje vertical An 40mm P 40mm H 1370mm negro		
Para modelos:	GGC2270B		

otros			
			
1			
código	692410	referencia	1.1.C.C09.01
descripción	cubierta para iluminación pos. de montaje interior L 230mm An 84mm H 2.5mm plástico UE 1 pzs		
Para modelos:	GGC1078, GGC1078B, GGC2270, GGC2270B		

			
1			
código	692370	referencia	1.1.C.C63.70
descripción	guía para junta L 740mm An 42mm H 19mm plástico UE 1 pzs		
Para modelos:	GCV1600		

			
1			
código	699315	referencia	SLZE0042
descripción	placa de sujeción para evaporador L 55mm An 27mm H 6mm		
Para modelos:	GBC1001, GBC1001S, GBC1001SS, GBC1002, GBC1002S, GBC1002SS, GBC1003, GBC1003S, GBC1003SS, GBC1102, GBC1103		

			
1			
código	692369	referencia	1.1.C.C63.71
descripción	soporte per termómetro An 81mm H 41mm plástico UE 1 pzs		
Para modelos:	GCV1600		

			
1			
código	699427	referencia	1.1.C.C03.01
descripción	tapón ciego H 5mm ø 12mm		
Para modelos:	GGC1078, GGC2270		

			
1			
código	699428	referencia	1.1.C.C03.02
descripción	tapón ciego H 5mm ø 12mm		
Para modelos:	GGC1078B, GGC2270B		

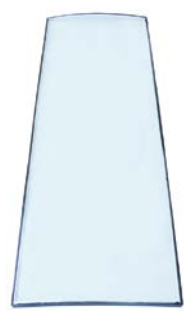
vidrios			
			
1			
código	692289	referencia	1.1.E.E2.02.65
descripción	vidrio An 460mm H 1360mm espesor 17mm curvado para frigorífico		
Para modelos:	GGC2270, GGC2270B		

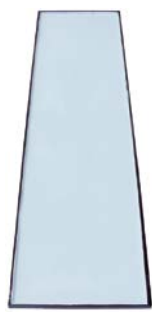
			
1			
código	692293	referencia	1.1.E.E2.02.44
descripción	vidrio L 1392mm An 376mm espesor 10mm plano pos. de montaje lateral para vitrinas frías		
Para modelos:	GGC2270, GGC2270B		

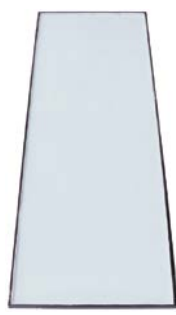
			
1			
código	699328	referencia	1.1.E.E2.02.45
descripción	vidrio L 1395mm An 464mm espesor 17.5mm pos. de montaje atrás escaparate refrigerado GGC2270		
Para modelos:	GGC2270, GGC2270B		

			
1			
código	699330	referencia	1.1.E.E2.02.76
descripción	vidrio L 360mm An 357mm espesor 10.5mm para puerta GCV1600		
Para modelos:	GCV1600		



1

código	692291	referencia	1.1.E.E2.02.64
descripción	vidrio L 635mm An 390mm espesor 10mm plano pos. de montaje puerta para vitrinas frías		
Para modelos:	GGC1078, GGC1078B		

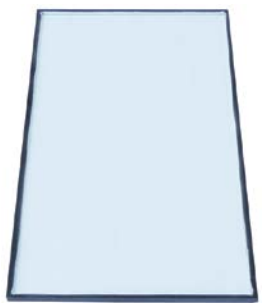

1

código	692290	referencia	1.1.E.E2.02.11
descripción	vidrio L 660mm An 332mm espesor 10mm plano pos. de montaje lateral para frigorífico		
Para modelos:	GGC1078, GGC1078B		



1

código	699327	referencia	1.1.E.E2.02.75
descripción	vidrio L 645mm An 595mm H 16mm espesor 8mm pos. de montaje derecho para vitrinas frías GCV1600		
Para modelos:	GCV1600		



1

código	699329	referencia	1.1.E.E2.04.15.A0
descripción	vidrio L 773mm An 710mm espesor 12mm pos. de montaje frontal para vitrinas frías GCV1600		
Para modelos:	GCV1600		



1

código	699326	referencia	1.1.E.E2.02.74
descripción	vidrio L 645mm An 595mm H 16mm espesor 8mm pos. de montaje izquierdo para vitrinas frías GCV1600		
Para modelos:	GCV1600		

accesorios



1

código	699431	referencia	1.1.B.B14.05
descripción	guía L 775mm		
Para modelos:	GCV1600		

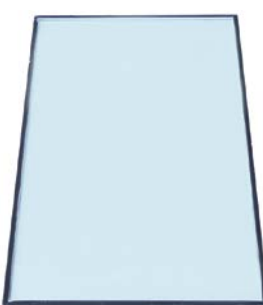

1

código	692292	referencia	1.1.E.E2.02.12
descripción	vidrio L 655mm An 390mm espesor 10mm plano pos. de montaje atrás para vitrinas frías		
Para modelos:	GGC1078, GGC1078B		

puertas



1

código	699405	referencia	S24AC50A0004
descripción	estantería L 255mm An 890mm H 30mm acero inoxidable		
Para modelos:	GSD2600		



1

código	698859	referencia	1.1.C.C11.02
descripción	marco de puerta L 425mm An 15mm H 28mm pos. de montaje arriba/abajo		
Para modelos:	GGC1078B		



1

código	699177	referencia	S24AC22A0001-RIGHT
descripción	puerta L 515mm An 425mm H 55mm pos. de montaje derecho		
Para modelos:	GPS2600, GSA2600, GSD2600, GSF2600		



1

código	699176	referencia	S24AC22A0001-LEFT
descripción	puerta L 515mm An 425mm H 55mm pos. de montaje izquierdo		
Para modelos:	GPS2600, GSA2600, GSD2600, GSF2600		

macánica de puertas

pernos



1

código	699424	referencia	1.1.B.B09.03
descripción	perno de puerta H 7mm An 7mm L 20.5mm pos. de montaje arriba		
Para modelos:	GGC1078, GGC1078B		

casquillos



1

código	699430	referencia	1.1.C.C13.02
descripción	casquillo H 15mm ø 10mm		
Para modelos:	GGC1078B, GGC2270, GGC2270B		

otros



1

código	694928	referencia	WJXC0000
descripción	imán de puerta L 46mm An 16mm H 14.5mm		
Para modelos:	GBC1102, GBC1103		



1

código	694929	referencia	WJXC0000
descripción	placa para magnético L 45mm An 12mm H 1.5mm distancia de sujeción 32mm		
Para modelos:	GBC1102, GBC1103		

para cocina vitrocerámica

encimeras vitrocerámicas

vidrios vitrocerámicos

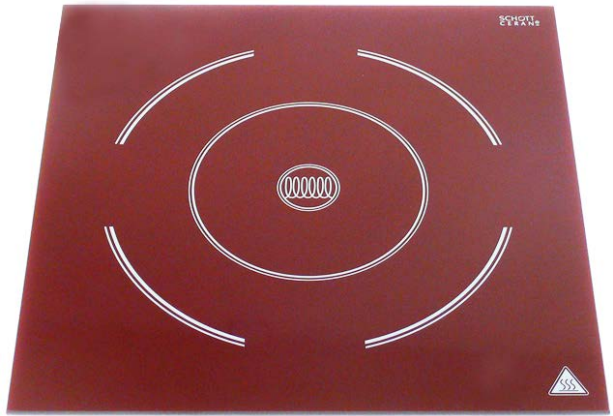

1

código	694579	referencia	MBF000032R
descripción	vidrio vitrocerámico L 300mm An 300mm espesor 4mm		
Para modelos:	GIC3035		

para freidoras

sujeciones



1

código	692544	referencia	2.02HDF4260701
descripción	lengüeta de sujeción L 63mm An 25mm H 15mm		
Para modelos:	GDF3024, GDF3028, GDF5028		

tapa



1

código	698544	referencia	3.CP0603070100
descripción	pomo seta asidero ø 50mm ø 70mm L 36mm plástico negro		
Para modelos:	GDF3004, GDF3008, GDF3024, GDF3028, GDF5008, GDF5028		

otros



1

código	694737	referencia	2.02HDF8A130001
descripción	revestimiento chapa L 63mm H 15mm int.ø 26mm		
Para modelos:	GDF5008, GDF5028		



1

código	699212	referencia	2.HDF8A460201
descripción	tubo acero inoxidable L 30mm An 13mm rosca M5		
Para modelos:	GDF5008, GDF5028		

para hornos a convección/combinados



1

código	692843	referencia	00004380
descripción	casquillo distanciador int.ø 7mm H 7.5mm ø ext. 17.5mm para vidrio blanco		
Para modelos:	GCO2001		

recambios y accesorios



1

código	693043	referencia	F02005
descripción	rejilla de protección		
Para modelos:	GTO1001, GTO2001		

vidrios



1

código	692841	referencia	21100870
---------------	--------	-------------------	----------

descripción vidrio L 447mm pos. de montaje interior An 585mm

Para modelos: GCO2001

accesorios para 692841



código	692842	referencia	21100880
---------------	--------	-------------------	----------

descripción vidrio L 450mm pos. de montaje exterior An 590mm



código	692843	referencia	00004380
---------------	--------	-------------------	----------

descripción casquillo distanciador int.ø 7mm H 7.5mm ø ext. 17.5mm para vidrio blanco



1

código	692842	referencia	21100880
---------------	--------	-------------------	----------

descripción vidrio L 450mm pos. de montaje exterior An 590mm

Para modelos: GCO2001

accesorios para 692842



código	692841	referencia	21100870
---------------	--------	-------------------	----------

descripción vidrio L 447mm pos. de montaje interior An 585mm



código	692843	referencia	00004380
---------------	--------	-------------------	----------

descripción casquillo distanciador int.ø 7mm H 7.5mm ø ext. 17.5mm para vidrio blanco



código	694993	referencia	00011680
---------------	--------	-------------------	----------

descripción manilla de puerta ø 18mm L 350mm acero inoxidable M5 negro mate



1

código	694950	referencia	VET30017
---------------	--------	-------------------	----------

descripción vidrio de puerta para horno a vapor combinado L 485mm pos. de montaje interior An 415mm espesor 4mm

Para modelos: GCO500



1

código	694951	referencia	VET05021
---------------	--------	-------------------	----------

descripción vidrio de puerta para horno a vapor combinado L 555mm pos. de montaje exterior An 425mm espesor 4mm

Para modelos: GCO500



Ventiladores - accesorios



1

código	701630	referencia	00012330
descripción	conducto de aire para soplador transversal para horno a vapor combinado plástico gris		
Para modelos:	GCO2001		

para máquinas hot-dog

tapa



1

código	694450	referencia	F05051
descripción	tapa para aparato hot dog ø 205mm		
Para modelos:	GHM1001		

cilindros de vidrio



1

código	693002	referencia	F05009
descripción	cilindro de vidrio ø 200mm Pyrexglas H 240mm		
Para modelos:	GHM1001		

brochetas



1

código	693018	referencia	F05010
descripción	brocheta para panecillos para aparato hot dog		
Para modelos:	GHM1001		

contenedores de agua



1

código	693005	referencia	F05022
descripción	contenedor de agua para aparato hot dog PTFE/aluminio		
Para modelos:	GHM1001		

para aparatos de inducción



1

código	970790	referencia	AB600022
descripción	filtro de grasa An 323mm H 144mm espesor 8mm inox capas 2 rejilla exterior 1 rejilla interior 1 para aparato de inducción		
Para modelos:	GIC3035		

para sartén basculante

otros



1

código	523510	referencia	00000000860
descripción	rodamiento de bolas radial tipo 6202-2RS árbol ø 15mm ø ext. 35mm An 11mm con arandelas de junta cojinete ranurado DIN 625-1		
Para modelos:	GFS1025, GFS2019, GFS2022, GFS2025, GFS2030		

para microondas

eléctrico

filtros de red

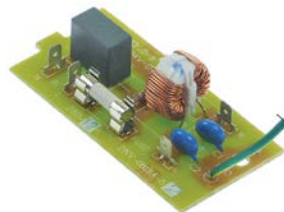

1

código	403188	referencia	263029001088
descripción	filtro de red microondas para GMW1025 250V 50/60Hz conductor 2 placa electrónica empalme conector Faston 4,8mm L 80mm H 20mm An 40mm placa electrónica UE 1 pzs longitud del cable 120mm tipo DNV-0818A-5		
Para modelos:	GMW1025		

placas cerámicas

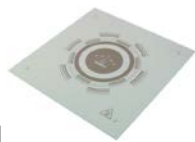

1

código	692350	referencia	243999000108
descripción	placa cerámica L 330mm An 335mm para microondas espesor 3.5mm GMW1025 UE 1 pzs		
Para modelos:	GMW1025		
accesorios para	692350		
	código	referencia	593219000016
	junta L 330mm An 325mm silicona para placa cerámica UE 1 pzs		

otros



1

código	601869	referencia	213149000023
descripción	soporte L 78mm An 20mm H 50mm para condensador UE 1 pzs		
Para modelos:	GMW1025		

puertas

láminas



1

código	692451	referencia	515059000119
descripción	lámina L 287mm An 159mm para puerta interior espesor 0.1mm transparente para GALANZ plástico UE 1 pzs		
Para modelos:	GMW1025		

para hornos

cajas y paneles frontales



1

código	692763	referencia	DEF30123
descripción	cubierta para horno de convección L 320mm An 325mm H 62mm		
Para modelos:	GCO500		

para saladettes

cajas y paneles frontales



1

código	692691	referencia	KITSR4AC4A00
descripción	distanciador juego 2 piezas para saladette An 25mm P 184mm H 11mm		
Para modelos:	GPS2600, GSD2600		



1

código	692692	referencia	KITSR4AC2A00
descripción	distanciador L 168/330/534mm 6 unidades		
Para modelos:	GSA2600		



1

código	692257	referencia	VRX.01 VRX.02 VRX.04 VRX.05 VRX.06 VRX33-38
descripción	kit de sujeción para vidrio para saladette 53 piezas UE 1 pzs 6x clip de sujeción 7x codo 12x tornillo de cabeza plana 14x casquillo 14x unión roscada		
Para modelos:	GHS1600, GHS2600		



1

código	993263	referencia	P04AC20A0006
descripción	tabla de corte L 950mm An 130mm H 20mm		
Para modelos:	GSA2600		

puertas



1

código	701546	referencia	S24AC22A0006
descripción	perno de puerta L 28mm pos. de montaje arriba rosca L 8mmmm		
Para modelos:	GPS2600, GSA2600, GSD2600, GSF2600		

para salamandras



1

código	692240	referencia	30045
descripción	bandeja colectora para salamandra L 350mm An 245mm		
Para modelos:	GTO1001, GTO2001		

para lavavajillas

calentadores de agua

calentadores de agua para lavavajillas



1

código	508429	referencia	900384
descripción	calentador de agua 3500W 230V ø 127mm L 400mm		
Para modelos:	GDW2001		

cámaras de aire

cámaras de aire



1

código	519643	referencia	905262
descripción	cámara de aire L 91mm An 54mm H 41mm tubo ø 4x7mm plástico		
Para modelos:	GDW2001		

accesorios para cámaras de aire



1

código	519162	referencia	904131
descripción	resorte		
Para modelos:	GDW2001		

bloques antirretorno

bloques antirretorno



1

código	516101	referencia	TR2433	
descripción	bloqueo antirretorno lavavajillas tubo ø 12mm			
Para modelos:	GDW2001			
repuestos para	516101			
	código	506367	referencia	—
		junta plana goma ø ext. 40mm int.ø 28mm espesor 1.8mm UE 1 pzs		

macánica de puertas

varillaje



1

código	519261	referencia	902740
---------------	--------	-------------------	--------

descripción	tirante de puerta barra de tracción
--------------------	-------------------------------------

Para modelos:	GDW2001
----------------------	---------

pernos roscados



1

código	519228	referencia	905424
---------------	--------	-------------------	--------

descripción	pieza roscada mecanismo de cierre
--------------------	-----------------------------------

Para modelos:	GDW2001
----------------------	---------

placas de fricción



1

código	519208	referencia	904952
---------------	--------	-------------------	--------

descripción	placa de fricción placa de fricción
--------------------	-------------------------------------

Para modelos:	GDW2001
----------------------	---------

bisagras



1

código	519035	referencia	901245
---------------	--------	-------------------	--------

descripción	bisagra de puerta taladros 3 bisagra
--------------------	--------------------------------------

Para modelos:	GDW2001
----------------------	---------

pernos de bisagra



1

código	519204	referencia	904795
---------------	--------	-------------------	--------

descripción	pasador de bisagra pasador de bisagra
--------------------	---------------------------------------

Para modelos:	GDW2001
----------------------	---------

cierres



1

código	519247	referencia	906121
---------------	--------	-------------------	--------

descripción	cierre de puerta cierre de puerta
--------------------	-----------------------------------

Para modelos:	GDW2001
----------------------	---------

accesorios para	519247
------------------------	--------



código	519050	referencia	—
descripción	tuerca rosca M12x1,75 H 4mm EC 16 inox UE 1 pzs para cierre de enganche		

uniones roscadas



1

código	519645	referencia	902111
---------------	--------	-------------------	--------

descripción	tuerca rosca 3/8" H 14mm EC 24 plástico UE 1 pzs
--------------------	--

Para modelos:	GDW2001
----------------------	---------

sistemas de lavado y aclarado



1

código	519238	referencia	906002
---------------	--------	-------------------	--------

descripción	arandela int.ø 15mm ø ext. 33mm espesor 0.8mm inox UE 1 pzs
--------------------	---

Para modelos:	GDW2001
----------------------	---------



1

código	501351	referencia	908154
---------------	--------	-------------------	--------

descripción	brida pos. de montaje arriba ø 91mm H 11mm int.ø 45mm agujero ø 5.5mm
--------------------	---

Para modelos:	GDW2001
----------------------	---------



1

código	519444	referencia	905449
---------------	--------	-------------------	--------

descripción	contrasoprote pos. de montaje arriba/abajo para soporte de brazo de lavado para Silanos
--------------------	---

Para modelos:	GDW2001
----------------------	---------

accesorios para	519444
------------------------	--------



código	519445	referencia	908141
---------------	--------	-------------------	--------

descripción	junta D1 ø 80mm D2 ø 50mm espesor 3mm con 4 orificios roscados
--------------------	--



1

código	517355	referencia	908702
---------------	--------	-------------------	--------

descripción	pieza distanciadora para soporte de brazo de lavado int.ø 44mm ø ext. 80mm espesor 18mm L 55mm plástico
--------------------	---

Para modelos:	GDW2001
----------------------	---------





1

código	501349	referencia	908456
descripción	reducción para eje de arbol de aclarado		
Para modelos:	GDW2001		



1

código	519085	referencia	902880
descripción	tornillo de cabeza moleteada ø 34mm rosca M6		
Para modelos:	GDW2001		



1

código	519537	referencia	908701
descripción	tubo de lavado ø 37mm L 720mm plástico apto para Silanos		
Para modelos:	GDW2001		

para tostadoras

recambios y accesorios



1

código	693043	referencia	F02005
descripción	rejilla de protección		
Para modelos:	GTO1001, GTO2001		

otros

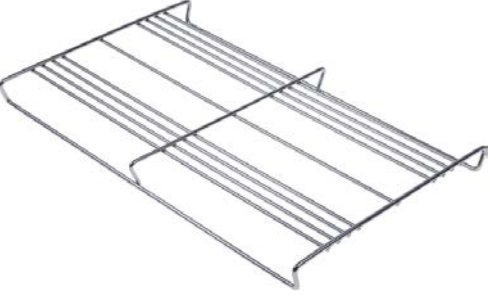

1

código	694449	referencia	F01069
descripción	rejilla de protección L 315mm An 200mm para tostadora H 24mm		
Para modelos:	GTO1001, GTO2001		

pomos

pomos universales



1

código	112733	referencia	3ZCK165BT19010101MGB
descripción	pomo marca cero T máx°C ø 55mm eje ø 6x4,6mm parte plana arriba negro		
Para modelos:	GDF3004, GDF3008, GDF3024, GDF3028, GDF5008, GDF5028		

otros



1

código	696506	referencia	2858
descripción	pomo para placa electrónica ø 26mm negro UE 1 pzs		
Para modelos:	GSM1000		

accesorios

rosetas



1

código	111806	referencia	3.ZCK165BT20010101-1
descripción	roseta pomo ø 16mm ø 55mm		
Para modelos:	GDF3004, GDF3008, GDF3024, GDF3028, GDF5008, GDF5028		

manillas y volantes

manillas de seta



1

código	697445	referencia	00000000677
descripción	pomo seta rosca M6 asidero ø 33mm L 26mm plástico negro		
Para modelos:	GFS2030		

			
1			
código	698641	referencia	00000001111
descripción	pomo seta rosca M6 asidero ø 34mm L 25mm aluminio		
Para modelos:	GFS1030		

barras de asidero

agarraderos específicas del fabricante

TECNOEKA

			
1			
código	694993	referencia	00011680
descripción	manilla de puerta ø 18mm L 350mm acero inoxidable M5 negro mate		
Para modelos:	GCO2001		

agarraderos

agarraderos

			
1			
código	699449	referencia	SLZB0020
descripción	asidero para frigorífico L 220mm An 36mm H 23mm gris dist. del agujero 120mm		
Para modelos:	GSC2336		

otros

			
1			
código	692402	referencia	1.1.C.C12.14
descripción	manilla gris para vitrina H 9.5mm L 85mm An 25mm distancia de sujeción 70mm UE 1 pzs		
Para modelos:	GGC1078		

			
1			
código	691960	referencia	A15015
descripción	manilla L 100mm An 32mm dist. del agujero 70mm para tapa		
Para modelos:	GTO1001, GTO2001		

			
1			
código	110921	referencia	A15016
descripción	manilla L 130mm An 39mm dist. del agujero 91mm UE 1 pzs		
Para modelos:	GHM1001		

			
1			
código	692545	referencia	3.HDF409010101
descripción	manilla L 96mm An 64mm dist. del agujero 73mm pos. de montaje panel lateral negro		
Para modelos:	GDF3004, GDF3024		

			
1			
código	698858	referencia	1.1.C.C12.15
descripción	manilla negro para vitrina H 9.5mm L 85mm An 25mm distancia de sujeción 70mm UE 1 pzs		
Para modelos:	GGC1078B		

			
1			
código	692409	referencia	1.1.C.C12.06
descripción	manilla de puerta L 100mm An 32mm dist. del agujero 68mm blanco		
Para modelos:	GGC2270		



cierres

dispositivos de cierre

específico del fabricante

WEIBO



código	692878	referencia	W0604007
descripción	cilindro de cerradura ángulo de rotación 90° longitud de pestillo 45mm anchura de pestillo 14mm para GFR2700/GRE2700 con 2 claves		
Para modelos:	GFR2700, GRE2700		

código	701592	referencia	CER30021 STA00028
descripción	juego de bisagras para hornos distancia de sujeción 140mm longitud de palanca 42mm distancia de ranura 15mm espesor de resorte 2.9mm L 170mm pos. de montaje izquierdo/derecho con contrasoporte UE 2 pzs		
Para modelos:	GCO500		

bisagras

bisagras para hornos

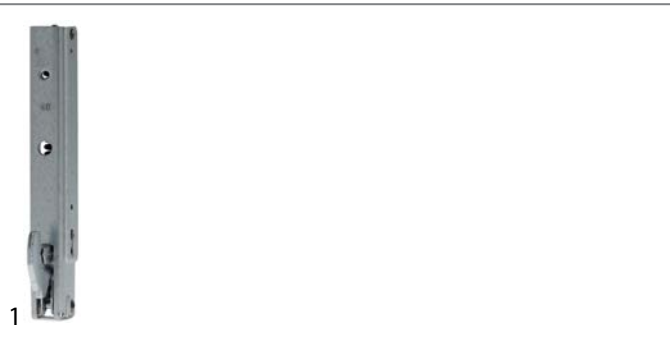

código	701573	referencia	00014610
descripción	bisagra para horno distancia de sujeción 142mm distancia de sujeción 2mm orejas de fijaciónmm longitud de palanca mm distancia de ranura 12mm espesor de resorte 3.3mm posición fijación longitud muelle 116mm L 170mm pos. de montaje izquierdo/derecho An 22mm		
Para modelos:	GCO2001		
accesorios para	701573		
	código	701631	referencia 00014600
	contrasoporte distancia de sujeción 119mm L 135mm An 12mm		

soporte de puerta

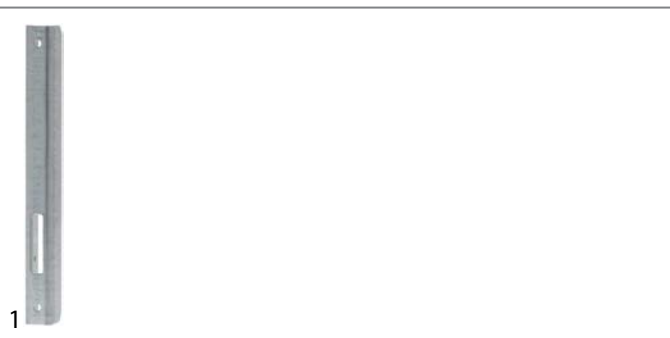

código	701564	referencia	46996000
descripción	bisagra L 130mm An 85mm H 38mm distancia de sujeción 48mm distancia de sujeción 2 33mm rosca M6 ø 8mm perno 13mm perno ø 8mm		
Para modelos:	GRE3600		

código	692690	referencia	S24AC22A0003
descripción	bisagra L 40mm An 70mm H 22mm distancia de sujeción 2 20mm		
Para modelos:	GPS2600, GSA2600, GSD2600, GSF2600		



código	701631	referencia	00014600
descripción	contrasoporte distancia de sujeción 119mm L 135mm An 12mm		
Para modelos:	GCO2001		
accesorios para	701631		
	código	701573	referencia 00014610
	bisagra para horno distancia de sujeción 142mm distancia de sujeción 2mm orejas de fijaciónmm longitud de palanca mm distancia de ranura 12mm espesor de resorte 3.3mm posición fijación longitud muelle 116mm L 170mm pos. de montaje izquierdo/derecho An 22mm		

código	699587	referencia	W0604033
descripción	bisagra L 87mm An 46mm pos. de montaje arriba derecha espesor 3.6mm perno 46mm perno ø 10.5mm para GFR2700/GRE2700		
Para modelos:	GFR2700, GRE2700		
accesorios para	699587		
	código	699588	referencia W0604037
	bisagra L 88mm An 50mm pos. de montaje abajo derecha espesor 3.6mm perno 29mm perno ø 11mm para GFR2700/GRE2700		

			
1			
código	699588	referencia	W0604037
descripción	bisagra L 88mm An 50mm pos. de montaje abajo derecha espesor 3.6mm perno 29mm perno ø 11mm para GFR2700/GRE2700		
Para modelos:	GFR2700, GRE2700		
repuestos para	699588		
	código	699568	referencia W0604038
	placa de asiento para bisagra de puerta batiente pos. de montaje abajo L 35mm An 25mm para GFR2700/GRE2700		
accesorios para	699588		
	código	699587	referencia W0604033
	bisagra L 87mm An 46mm pos. de montaje arriba derecha espesor 3.6mm perno 46mm perno ø 10.5mm para GFR2700/GRE2700		

			
1			
código	701563	referencia	43870000
descripción	bisagra L 98mm An 48mm H 38mm distancia de sujeción 40mm distancia de sujeción 2 20mm rosca M6		
Para modelos:	GFR3600S, GRE3600, GRE3600S		

			
1			
código	694866	referencia	WJMA2003
descripción	bisagra pos. de montaje abajo L 82mm An 53mm H 43mm distancia de sujeción 30mm distancia de sujeción 2 56mm espesor 4mm perno 20mm perno ø 7mm		
Para modelos:	GSC2336		

			
1			
código	694865	referencia	WJMA0004
descripción	bisagra pos. de montaje arriba L 50mm An 33mm H 42mm distancia de sujeción 27mm espesor 3mm perno 32.5mm perno ø 9mm UE 1kg		
Para modelos:	GSC2336		

			
1			
código	701280	referencia	WJMA4002
descripción	bisagra de puerta L 42mm An 33mm H 82mm pos. de montaje abajo derecha/izquierda juego UE 1 pzs		
Para modelos:	GSC1100G		

			
1			
código	701281	referencia	WJMA4005
descripción	bisagra de puerta L 43mm An 82mm H 71mm pos. de montaje arriba derecha/izquierda juego UE 1 pzs		
Para modelos:	GSC1100G		

			
1			
código	698866	referencia	GPC1046-12 GPC1088-13
descripción	bisagra de puerta L 90mm An 40mm H 19mm pos. de montaje abajo perno 13mm perno ø 10.5mm		
Para modelos:	GPC1046, GPC1088		

			
1			
código	698863	referencia	GPC1046-04 GPC1088-05
descripción	bisagra de puerta L 90mm An 40mm H 19mm pos. de montaje arriba perno 13mm perno ø 10.5mm		
Para modelos:	GPC1046, GPC1088		

			
1			
código	692421	referencia	1.1.C.C13.01
descripción	casquillo H 15mm ø 10/13mm int.ø 7mm plástico para bisagra de puerta batiente UE 1 pzs		
Para modelos:	GGC1078, GGC2270, GGC2270B		



1

código	701567	referencia	41649000
descripción	casquillo L 11mm ø 11/15mm espesor 2mm		
Para modelos:	GFR3600S, GRE3600, GRE3600S		



1

código	701572	referencia	10534002
descripción	casquillo ø 18.5mm int.ø 12mm		
Para modelos:	GFR3600S		



1

código	699419	referencia	1.1.B.B09.01
descripción	cojinete giratorio L 55mm An 15mm H 14mm distancia de sujeción 26mm pos. de montaje arriba		
Para modelos:	GGC1078, GGC1078B		



1

código	701566	referencia	46997000
descripción	cojinete giratorio L 72mm An 39mm H 30mm distancia de sujeción 25mm distancia de sujeción 2 25mm pos. de montaje derecho		
Para modelos:	GRE3600		



1

código	701565	referencia	48205000
descripción	cojinete giratorio L 72mm An 39mm H 30mm distancia de sujeción 25mm distancia de sujeción 2 25mm pos. de montaje izquierdo		
Para modelos:	GRE3600		



1

código	699423	referencia	1.1.B.B09.17
descripción	cojinete giratorio L 85mm An 17mm H 17mm distancia de sujeción 48mm pos. de montaje arriba		
Para modelos:	GGC2270, GGC2270B		



1

código	692406	referencia	1.1.B.B10.17
descripción	perno H 16.5mm ø 10/14mm int.ø 7mm latón para bisagra de puerta batiente UE 1 pzs		
Para modelos:	GGC2270, GGC2270B		



1

código	701562	referencia	44447000
descripción	perno L 36mm An 22mm rosca M6 perno 12mm perno ø 12mm		
Para modelos:	GFR3600S, GRE3600, GRE3600S		

accesorios

casquillos



1

código	701642	referencia	W0409843
descripción	casquillo abajo para bisagra de puerta batiente int.ø 11mm ø ext. 13mm L 26mm para GFR2700/GRE2700		
Para modelos:	GFR2700, GRE2700		



1

código	701641	referencia	W0409842
descripción	casquillo arriba para bisagra de puerta batiente int.ø 11mm ø ext. 13mm L 29.5mm para GFR2700/GRE2700		
Para modelos:	GFR2700, GRE2700		



base



código	699568	referencia	W0604038
descripción	placa de asiento para bisagra de puerta batiente pos. de montaje abajo L 35mm An 25mm para GFR2700/GRE2700		
Para modelos:	GFR2700, GRE2700		



código	699569	referencia	W0604030
descripción	placa de asiento para bisagra de puerta batiente pos. de montaje derecho L 74mm An 42mm para GFR2700/GRE2700		
Para modelos:	GFR2700, GRE2700		

con placa de sujeción



código	701640	referencia	W0409018
descripción	pie de aparato tubo ø 51mm dimensiones de la placa 70x70mm dist. del agujero 50mm H 11,7-18mm UE 1 pzs para GFR2700/GRE2700 ajustable		
Para modelos:	GFR2700, GRE2700		

pies enroscables



código	701230	referencia	900888
descripción	kit pies de aparato rosca M5 rosca L 10mm ø 22mm H 12mm goma EC UE 4 pzs taladro ø 5/10mm		
Para modelos:	GJU1001		

filtros

accesorios

material de sujeción

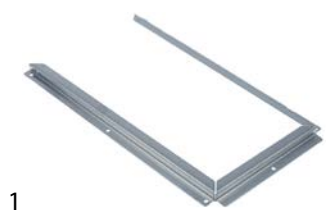

código	694581	referencia	WJB000079R
descripción	marco L 317mm An 170mm H 9mm para filtro		
Para modelos:	GIC3035		



código	700972	referencia	S900.13
descripción	pie de aparato rosca M10 rosca L 16mm ø 29mm H 11.5mm UE 1 pzs para frigorífico		
Para modelos:	GHS1600, GHS2600		

pies para aparatos y tapas terminales

pies para aparatos

con fijación atornillada



código	701640	referencia	W0409018
descripción	pie de aparato tubo ø 51mm dimensiones de la placa 70x70mm dist. del agujero 50mm H 11,7-18mm UE 1 pzs para GFR2700/GRE2700 ajustable		
Para modelos:	GFR2700, GRE2700		





código	701593	referencia	PIE30010
descripción	pie de aparato rosca M10 rosca L 18.5mm ø 49mm H 35mm plástico UE 4 pzs		
Para modelos:	GCO500		



código	692235	referencia	A13012
descripción	pie de aparato rosca M10 rosca L 20mm ø 26mm H 6mm UE 1 pzs		
Para modelos:	GEG2001		





			
1			
código	802156	referencia	00002790
descripción	pie de aparato rosca M10 rosca L 20mm ø 60mm H 50mm UE 1 pzs		
Para modelos:	GCO2001		

			
1			
código	698495	referencia	00000001251
descripción	pie de aparato rosca M8 rosca L 9mm ø 48mm H 43mm cónico aluminio EC UE 1 pzs		
Para modelos:	GFS1030		

			
1			
código	701112	referencia	I0403014
descripción	pie de aparato rosca M10 rosca L 43mm ø 29mm H 52mm plástico EC 35 UE 1 pzs		
Para modelos:	GRE3600, GRE3600S		

pies roscados

			
1			
código	691814	referencia	A13003
descripción	pie de aparato ø 22mm H 20mm taladro ø 4mm UE 1 pzs		
Para modelos:	GHM1001, GTO1001, GTO2001		

			
1			
código	701451	referencia	00000001240
descripción	pie de aparato rosca M5 rosca L 13mm ø 37.5mm H 25mm cónico aluminio EC UE 1 pzs taladro ø 6mm		
Para modelos:	GFS1025		

			
1			
código	698546	referencia	3.0000161
descripción	pie de aparato ø 29mm H 16mm goma taladro ø 6mm UE 1 pzs		
Para modelos:	GDF3004, GDF3008, GDF3024, GDF3028, GDF5008, GDF5028		

			
1			
código	701219	referencia	AB300035
descripción	pie de aparato rosca M5 rosca L 9mm ø 33mm H 34mm UE 1 pzs		
Para modelos:	GIC3035		

			
1			
código	697433	referencia	00000000140 00000700140
descripción	pie de aparato ø 35mm H 26mm taladro ø 5mm UE 1 pzs		
Para modelos:	GFS1022, GFS2019, GFS2022, GFS2025, GFS2030		

			
1			
código	701220	referencia	AB300055
descripción	pie de aparato rosca M6 rosca L 20mm ø 33mm H 20mm EC 12 UE 1 pzs		
Para modelos:	GIC3035		

pies de aparatos insertables

			
1			
código	701251	referencia	223189000015
descripción	pie de aparato ø 20mm H 12mm montaje ø 8mm medida de montaje 19mm altura total 19mm plástico UE 1 pzs		
Para modelos:	GMW1025		

otros

con placa de sujeción

ø30mm



1

código	701277 ¹	referencia	WJLA1001 WJLA1009
descripción	rueda pivotante 2 con y 2 sin freno ø 30mm placa de sujeción carcasa chapa de acero tincado dimensiones de la placa 61x51mm dist. del agujero ø 30mm capacidad 60kg cojinete cojinete de fricción cuerpo de rueda PVC superficie fricción PVC H 44mm ancho de rueda 23.5mm		
Para modelos:	GBC1001, GBC1001S, GBC1001SS, GBC1002, GBC1002S, GBC1002SS, GBC1003, GBC1003S, GBC1003SS, GBC1102, GBC1103, GSC2336		

¹con freno total

ø75mm



1

código	701282	referencia	WJLA1002
descripción	juego de ruedas pivotantes 2 con y 2 sin freno ø 75mm sujeción placa 102x83mm carcasa chapa de acero tincado dist. del agujero 55/75mm cojinete cojinete de fricción H 112mm ancho de rueda 31mm UE 4 pzs		
Para modelos:	GSC1100G		

con espiga

ø40mm



1

código	701120	referencia	1.1.B.B10.95 1.1.B.B10.96
descripción	juego de ruedas 2 con y 2 sin freno ø 40mm con perno roscado carcasa acero cromado rosca L 24mm rosca ø M10x1,5mm capacidad 60kg cojinete rodamiento de bolas cuerpo de rueda nylon superficie fricción nylon H 68mm ancho de rueda 20mm UE 4 pzs		
Para modelos:	GGC2270, GGC2270B		

cestos

tamices para empanar



1

código	970869	referencia	2.HDF405069510
descripción	tamiz para empanar L 220mm An 160mm H 35mm 4 litros		
Para modelos:	GDF3004, GDF3024		



1

código	970870	referencia	2.HDF812020609510
descripción	tamiz para empanar L 245mm An 200mm H 35mm 8 litros		
Para modelos:	GDF3008, GDF3028, GDF5008, GDF5028		

cestas alambre para hot dog



1

código	693004	referencia	F04012
descripción	cesto de rejilla para grill para hot dog ø 180mm H 210mm		
Para modelos:	GHM1001		



rejillas y rieles guía

parrillas

universal

sin reborde



código	970801	referencia	WJGA9008
descripción	parrilla An 345mm P 400mm acero cromado anillo externo reforzado 6mm refuerzos longitudinales 2.5mm traviesas 4 UE 1 pzs		
Para modelos:	GBC1003, GBC1003S, GBC1003SS, GBC1103		



código	970800	referencia	WJGA9002
descripción	parrilla An 345mm P 500mm acero cromado anillo externo reforzado 6mm refuerzos longitudinales 2.5mm traviesas 4 UE 1 pzs		
Para modelos:	GBC1001, GBC1001S, GBC1001SS		



código	970747	referencia	F01070
descripción	parrilla An 350mm P 240mm H 7mm inox para tostadora anillo externo reforzado 4mm refuerzos longitudinales 3mm traviesas ROLLER GRILL		
Para modelos:	GTO1001, GTO2001		

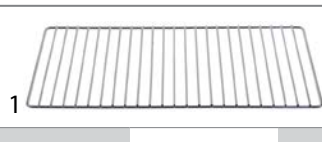

código	970905	referencia	GPC1046-13 GPC1088-14-half size
descripción	parrilla An 365mm P 165mm H 7mm anillo externo reforzado 4mm refuerzos longitudinales 3mm		
Para modelos:	GPC1046, GPC1088		



código	970906	referencia	WJGA9005
descripción	parrilla An 400mm P 345mm acero cromado anillo externo reforzado 6mm traviesas 4		
Para modelos:	GBC1002, GBC1002S, GBC1002SS, GBC1003, GBC1003S, GBC1102		

con reborde



código	970925	referencia	S14AC29A0001
descripción	parrilla An 325mm P 570mm GN 1/1 H 55mm acero plastificado anillo externo reforzado 7.5mm refuerzos longitudinales 4mm traviesas 3 gris		
Para modelos:	GPS2600, GSA2600, GSD2600, GSF2600		

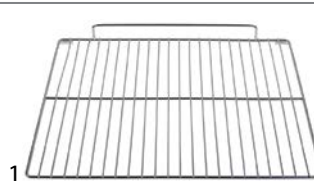

código	970904	referencia	GPC1088-14-full size
descripción	parrilla An 350mm P 295mm H 30mm acero cromado anillo externo reforzado 4mm refuerzos longitudinales 2mm traviesas 1 UE 2 pzs		
Para modelos:	GPC1088		



código	970795	referencia	1.1.B.B25.15
descripción	parrilla An 735mm P 235mm H 37mm acero cromado anillo externo reforzado 8mm refuerzos longitudinales 3mm traviesas 1		
Para modelos:	GCV1600		



código	970794	referencia	1.1.B.B25.16
descripción	parrilla An 735mm P 365mm H 35mm acero cromado anillo externo reforzado 8mm refuerzos longitudinales 3mm traviesas 1		
Para modelos:	GCV1600		

específico del fabricante



código	698856	referencia	1.1.B.B02.01.03
descripción	parrilla An 360mm P 305mm acero plastificado		
Para modelos:	GGC1078B		

accesorios para	698856	código	692400	referencia	1.1.C.C10.07
	soporte de bandeja L 28.5mm An 14mm H 17.5mm plástico UE 1 pzs				
código	698857	referencia	1.1.C.C10.08		
	soporte de bandeja L 28.5mm An 14mm H 17.5mm plástico UE 1 pzs				



1

código	970876	referencia	1.1.B.B02.01.01
descripción	parrilla An 360mm P 305mm acero plastificado		
Para modelos:	GGC1078		



1

código	692339	referencia	1.1.B.B02.04.01
descripción	parrilla An 430mm P 390mm H 8mm acero plastificado refrigeración anillo externo reforzado 8mm refuerzos longitudinales 3.6mm traviesas 5 blanco		
Para modelos:	GGC2270		



1

código	692696	referencia	1.1.B.B02.04.02
descripción	parrilla An 430mm P 390mm H 8mm acero plastificado refrigeración anillo externo reforzado 8mm refuerzos longitudinales 3.6mm traviesas 5 negro		
Para modelos:	GGC2270B		



1

código	970981	referencia	W0402369
descripción	parrilla An 530mm P 650mm acero plastificado traviesas 2 apto para GFR2700		
Para modelos:	GFR2700		



1

código	970799	referencia	WJGA4078
descripción	parrilla An 540mm P 505mm H 41mm acero plastificado anillo externo reforzado 6mm refuerzos longitudinales 3mm traviesas 3 blanco UE 1 pzs		
Para modelos:	GSC1100G		



1

código	970982	referencia	W0402040
descripción	parrilla An 620mm P 530mm acero plastificado con tope traviesas 2 apto para GRE2700		
Para modelos:	GRE2700		



1

código	970980	referencia	W0402366
descripción	parrilla An 630mm P 602mm acero plastificado traviesas 2 apto para GFR2700/GRE2700		
Para modelos:	GFR2700, GRE2700		



1

código	970930	referencia	44714000
descripción	parrilla An 650mm P 330mm H 9mm anillo externo reforzado 7mm refuerzos longitudinales 3mm traviesas 1		
Para modelos:	GRE3600, GRE3600S		

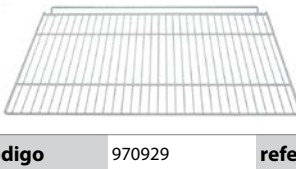

1

código	970929	referencia	44379000
descripción	parrilla An 665mm P 560mm H 30mm anillo externo reforzado 7mm refuerzos longitudinales 3mm traviesas 2		
Para modelos:	GFR3600S, GRE3600, GRE3600S		

accesorios



1

código	691917	referencia	F03006
descripción	asidero de rejilla L 204mm An 80mm		
Para modelos:	GTO1001, GTO2001		

portarejillas



1

código	701252	referencia	1.1.B.B25.35
descripción	guía para portarejillas L 405mm Hmm pos. de montaje izquierdo/derecho An 19mm inox UE 1 pzs		
Para modelos:	GCV1600		





1

código	692368	referencia	1.1.B.B25.27
descripción	portarrejillas L 220mm H 83mm pos. de montaje abajo derecha inox UE 1 pzs		
Para modelos:	GCV1600		



1

código	692366	referencia	1.1.B.B25.29
descripción	portarrejillas L 220mm H 83mm pos. de montaje arriba derecha inox UE 1 pzs		
Para modelos:	GCV1600		



1

código	692365	referencia	1.1.B.B25.28
descripción	portarrejillas L 220mm H 83mm pos. de montaje arriba izquierda inox UE 1 pzs		
Para modelos:	GCV1600		



1

código	692367	referencia	1.1.B.B25.26
descripción	portarrejillas L 320mm H 83mm pos. de montaje abajo izquierda inox UE 1 pzs		
Para modelos:	GCV1600		

rieles guía y soportos

específico del fabricante



1

código	701550	referencia	S24AC29A0002
descripción	cremallera L 244mm An 50mm H 8mm pos. de montaje anterior		
Para modelos:	GPS2600, GSA2600, GSD2600, GSF2600		



1

código	701549	referencia	S24AC29A0005
descripción	cremallera L 245mm An 40mm H 30mm pos. de montaje derecho		
Para modelos:	GPS2600, GSA2600, GSD2600, GSF2600		





1

código	701548	referencia	S24AC29A0004
descripción	cremallera L 245mm An 40mm H 30mm pos. de montaje izquierdo		
Para modelos:	GPS2600, GSA2600, GSD2600, GSF2600		



1

código	699585	referencia	80037402
descripción	cremallera L 985mm An 57mm H 38mm pos. de montaje izquierdo/derecho tamaño orificio 15x15mm dist. del agujero 55mm 18 orificios para GFR2700/GRE2700		
Para modelos:	GFR2700, GRE2700		
accesorios para	699585		
	código	referencia	80037407
	701643		
descripción	guía forma U L 620mm An 15mm H 20mm pos. de montaje izquierdo para GFR2700/GRE2700		
	código	referencia	80037408
	701644		
descripción	guía forma U L 620mm An 15mm H 20mm pos. de montaje derecho para GFR2700/GRE2700		



código	699231	referencia	I0402137
descripción	guida blanco L 1350mm An 20mm H 5mm UE 1		
Para modelos:	GRE3600, GRE3600S		



código	701644	referencia	80037408
descripción	guida forma U L 620mm An 15mm H 20mm pos. de montaje derecho para GFR2700/GRE2700		
Para modelos:	GFR2700, GRE2700		
accesorios para	701644		
	código	referencia	80037407
	guida forma U L 620mm An 15mm H 20mm pos. de montaje izquierdo para GFR2700/GRE2700		



código	701643	referencia	80037407
descripción	guida forma U L 620mm An 15mm H 20mm pos. de montaje izquierdo para GFR2700/GRE2700		
Para modelos:	GFR2700, GRE2700		
accesorios para	701643		
	código	referencia	80037408
	guida forma U L 620mm An 15mm H 20mm pos. de montaje derecho para GFR2700/GRE2700		



código	698870	referencia	LCCJ2001
descripción	guida L 390mm An 25mm pos. de montaje izquierdo/derecho altura interior 4mm		
Para modelos:	GBC1001, GBC1001S, GBC1001SS, GBC1002, GBC1002S, GBC1002SS, GBC1003, GBC1003S, GBC1003SS, GBC1102, GBC1103		



código	696443	referencia	KITGD4AC2A00
descripción	par de barras de ajuste forma U L 548mm An 20mm altura interior 13mm pos. de montaje izquierdo/derecho		
Para modelos:	GPS2600, GSA2600, GSD2600, GSF2600		



código	692398	referencia	LCCK0002
descripción	soporte de bandeja L 24mm An 9mm H 29mm aluminio para frigorífico UE 1 pzs		
Para modelos:	GBC1001, GBC1001S, GBC1001SS, GBC1002, GBC1002S, GBC1002SS, GBC1003, GBC1003S, GBC1003SS, GBC1102, GBC1103		



código	692400	referencia	1.1.C.C10.07
descripción	soporte de bandeja L 28.5mm An 14mm H 17.5mm plástico UE 1 pzs		
Para modelos:	GGC1078		



código	698857	referencia	1.1.C.C10.08
descripción	soporte de bandeja L 28.5mm An 14mm H 17.5mm plástico UE 1 pzs		
Para modelos:	GGC1078B		



código	692408	referencia	1.1.C.C10.09
descripción	soporte de bandeja L 38.5mm An 14mm H 18mm plástico UE 1 pzs		
Para modelos:	GGC2270		

código	699416	referencia	1.1.C.C10.10
descripción	soporte de bandeja L 38.5mm An 14mm H 18mm plástico UE 1 pzs		
Para modelos:	GGC2270B		

juntas

juntas para frigoríficos

juntas insertables

perfil 9149

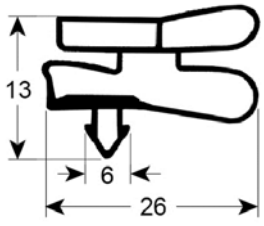

código	902216	referencia	R04AC22A0002
descripción	junta para frigorífico perfil 9149 An 385mm L 480mm medida inserción		
Para modelos:	GPS2600, GSA2600, GSD2600, GSF2600		

perfil 9058



código	902395	referencia	44404000
descripción	junta para frigorífico perfil 9058 An 770mm L 1810mm medida inserción UE 1		
Para modelos:	GFR3600S, GRE3600, GRE3600S		

perfil 9750

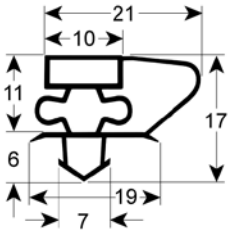

código	902514	referencia	W0404514
descripción	junta para frigorífico perfil 9750 An 660mm L 1537mm medida inserción		
Para modelos:	GFR2700, GRE2700		

perfil 9156

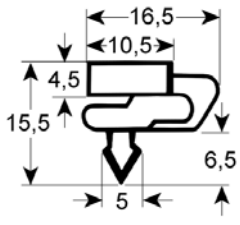

código	901662	referencia	SLJP4007
descripción	junta de puerta perfil 9156 An 569mm L 1295mm medida inserción UE 1 pzs		
Para modelos:	GSC1100G		

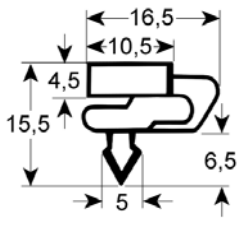

código	901648	referencia	SLJP2010
descripción	junta para frigorífico perfil 9156 An 595mm L 1340mm medida inserción UE 1 pzs		
Para modelos:	GSC2336		

perfil 9930



código	901645	referencia	1.1.C.63.69
descripción	junta para frigorífico perfil 9930 Anmm L 746mm medida inserción		
Para modelos:	GCV1600		

juntas roscadas

perfil 9968

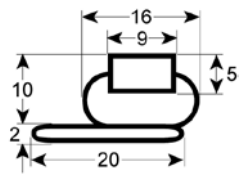

código	901649	referencia	1.1.E.E1.35
descripción	junta para frigorífico perfil 9968 An 418mm L 658mm medidas exteriores con refuerzo de metal UE 1 pzs		
Para modelos:	GGC1078B		

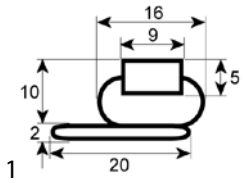

código	901650	referencia	1.1.E.E1.25
descripción	junta para frigorífico perfil 9968 An 515mm L 1390mm medidas exteriores con refuerzo de metal UE 1 pzs		
Para modelos:	GGC2270		

perfil 9910

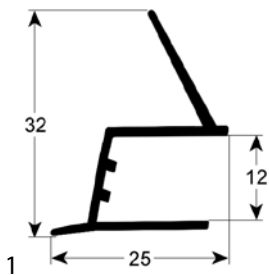

código	901646	referencia	1.1.C.C63.76
descripción	junta para frigorífico perfil 9910 Anmm L 735mm medidas exteriores UE 1 pos. de montaje derecho		
Para modelos:	GCV1600		

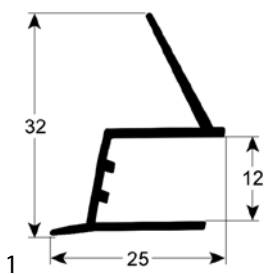

código	901651	referencia	1.1.C.C63.67
descripción	junta para frigorífico perfil 9910 Anmm L 735mm medidas exteriores UE 1 pos. de montaje izquierdo		
Para modelos:	GCV1600		

juntas térmicas

juntas para puertas

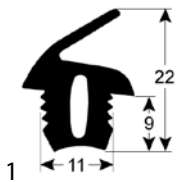

código	902446	referencia	GUA30015
descripción	junta de puerta perfil 2718 L 5500mm		
Para modelos:	GCO500		

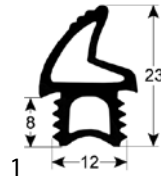

código	902497	referencia	01000770
descripción	junta de puerta perfil 2764 L 1020mm para TECNOEKA		
Para modelos:	GCO2001		

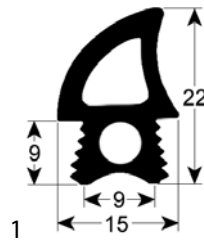

código	902419	referencia	01000810
descripción	junta de puerta perfil 2767 L 1780mm para TECNOEKA		
Para modelos:	GCO2001		

juntas tóricas

EPDM

ø1.50mm

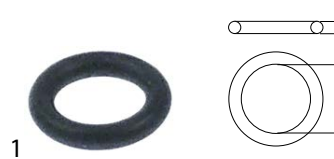

código	532648	referencia	2859
descripción	junta tórica EPDM espesor 1.5mm int.ø 5mm UE 1 pzs		
Para modelos:	GSM1000		

ø3,00mm



código	510955	referencia	00002001
descripción	junta tórica EPDM espesor 3mm int.ø 6mm UE 1 pzs		
Para modelos:	GCO2001		

ø5,34mm

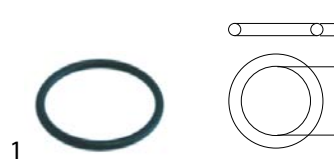

código	521120	referencia	907981
descripción	junta tórica EPDM espesor 5.34mm int.ø 37.47mm UE 1 pzs		
Para modelos:	GDW2001		

otros



código	532647	referencia	900970
descripción	junta tórica EPDM espesor 1.8mm int.ø 11.8mm UE 1 pzs		
Para modelos:	GJU1001		

anillos de junta

juntas de goma



código	519114	referencia	903260
descripción	junta plana goma ø ext. 25mm int.ø 16.5mm espesor 2mm UE 1 pzs		
Para modelos:	GDW2001		

juntas de árbol

juntas de árbol



código	698383	referencia	0632
descripción	junta de árbol int.ø 4mm ø ext. 12mm para triturador portátil H 6.3mm		
Para modelos:	GSM1000		



código	697475	referencia	00000012671
descripción	junta radial int.ø 20mm ø ext. 30mm espesor 5mm		
Para modelos:	GFS1025		

otros



código	511953	referencia	900871
descripción	juego de juntas para exprimidor		
Para modelos:	GJU1001		

juntas especiales

para microondas



código	901698	referencia	593219000016
descripción	junta L 330mm An 325mm silicona para placa cerámica UE 1 pzs		
Para modelos:	GMW1025		

otros



código	698543	referencia	3.0000403
descripción	junta altura exterior 4mm ø ext. 25mm int.ø 16mm		
Para modelos:	GDF3008, GDF3028, GDF5008, GDF5028		



código	698545	referencia	3.0000404
descripción	junta ø ext. 31mm int.ø 21mm		
Para modelos:	GDF3008, GDF3028, GDF5008, GDF5028		

juntas patra brazos de lavado



código	519445	referencia	908141
descripción	junta D1 ø 80mm D2 ø 50mm espesor 3mm con 4 orificios roscados		
Para modelos:	GDW2001		

componentes para el circuito frigorífico

válvulas

válvulas Schrader

válvulas Schrader completas



1	código	750636	referencia	S900.42
	descripción	válvula Schrader completo empalme 1/4"SAE ø 6mm L 120mm		
	Para modelos:	GHS1600, GHS2600		

filtros deshidratadores antiácidos

accesorios

soportes



1	código	699297	referencia	SLJAC008
	descripción	soporte L 40mm An 30mm H 31mm int.ø 18mm ø ext. 22mm para deshidratador		
	Para modelos:	GBC1001, GBC1001S, GBC1001SS, GBC1002, GBC1002S, GBC1002SS, GBC1003, GBC1003S, GBC1003SS, GBC1102, GBC1103, GSC1100G, GSC2336		

otros



1	código	750381	referencia	TCGV0002
	descripción	deshidratador ø 18.5mm L 115.5mm empalme 2,4/5,2mm UE 1 pzs		
	Para modelos:	GBC1001, GBC1001S, GBC1001SS, GBC1002, GBC1002S, GBC1002SS, GBC1003, GBC1003S, GBC1003SS, GBC1102, GBC1103, GSC2336		



1	código	750693	referencia	1.1.A.A04.01
	descripción	deshidratador ø 19mm L 120.5mm empalme 2/5mm UE 1 pzs		
	Para modelos:	GCV1600, GGC1078, GGC1078B		



1	código	750378	referencia	C01AE66A0001 C04AC26A0001
	descripción	deshidratador ø 19mm L 145mm empalme 4,5/8mm tipo XH9 UE 1 pzs		
	Para modelos:	GDS2600, GPS2600, GSA2600, GSD2600, GSF2600		



1	código	750748	referencia	W0204101
	descripción	deshidratador ø 19mm L 166mm empalme 2,7/5,2 para GFR2700/ GRE2700		
	Para modelos:	GFR2700, GRE2700		



1	código	750694	referencia	1.1.A.A04.06
	descripción	deshidratador ø 25mm L 144mm empalme 6/8mm UE 1 pzs		
	Para modelos:	GGC2270, GGC2270B		



1	código	750324	referencia	S900.44
	descripción	deshidratador tamaño 20g ø 23mm L 117mm empalme 4,8/8,3mm		
	Para modelos:	GHS1600, GHS2600		



1	código	750382	referencia	TCGV0009	
	descripción	deshidratador ø 18.5mm L 120mm empalme 4/7mm UE 1 pzs			
	Para modelos:	GSC1100G			
	accesorios para	750382			
		código	694868	referencia	—
			soporte para deshidratador L 40mm An 30mm H 31mm UE 1 pzs		

tubos para refrigeración

tubos de cobre sin aislar



1	código	694931	referencia	VRX.15
	descripción	capilar int.ø 0.8mm L 2340m ø ext. 2mm		
	Para modelos:	GHS1600, GHS2600		



1

código	692407	referencia	1.1.B.B06.21
descripción	tubo de cobre cobre int.ø 3.8mm L 0.1m ø ext. 4.8mm UE 1 pzs		
Para modelos:	GGC2270, GGC2270B		



1

código	692730	referencia	TCGO3004
descripción	tubo de cobre int.ø 4mm L 0.095m ø ext. 6mm		
Para modelos:	GBC1002, GBC1002S, GBC1003, GBC1003S, GBC1102, GBC1103		



1

código	692418	referencia	1.1.B.B06.26
descripción	tubo para refrigeración cobre int.ø 5mm L 1m ø ext. 6mm UE 1		
Para modelos:	GCV1600, GGC1078, GGC1078B, GGC2270, GGC2270B		



1

código	692872	referencia	W0210284
descripción	tubo para refrigeración int.ø 2/3mm L 0.4m refrigeración ø ext. 5mm GFR2700		
Para modelos:	GFR2700		



1

código	692871	referencia	W0210452
descripción	tubo para refrigeración int.ø 3/7mm L 0.38m refrigeración ø ext. 6/8mm GFR2700		
Para modelos:	GFR2700		



1

código	692874	referencia	W0210412
descripción	tubo para refrigeración int.ø 5.5mm L 0.3m refrigeración ø ext. 6.5mm GFR2700		
Para modelos:	GFR2700		



1

código	692876	referencia	W0210411
descripción	tubo para refrigeración int.ø 5mm L 0.28m refrigeración ø ext. 6.5mm GFR2700		
Para modelos:	GFR2700		



1

código	692875	referencia	W0210416
descripción	tubo para refrigeración int.ø 6,5/7,5mm L 0.38m refrigeración ø ext. 7,5/8,5mm GRE2700		
Para modelos:	GRE2700		



1



código	692873	referencia	W0210282	
descripción	tubo para refrigeración int.ø 6.5mm L 0.36m refrigeración ø ext. 8mm GFR2700			
Para modelos:	GFR2700			
accesorios para	692873			
	código	696787	referencia	W0208009
	pieza T cobre int.ø 4.5mm ø ext. 6mm refrigeración para GFR2700			

1 

código	692877	referencia	W0210417
descripción	tubo para refrigeración int.ø 6/7mm L 0.41m refrigeración ø ext. 7/8mm GRE2700		
Para modelos:	GRE2700		

tubos de cobre aislados



código	696789	referencia	W0210413
descripción	tubo de cobre con aislamiento diámetro ø 6 para frigorífico GFR2700/GRE2700		
Para modelos:	GFR2700, GRE2700		
accesorios para	696789		
	código	referencia	W04102051
	cubierta ø 20mm L 400mm An 43mm plástico UE 1 pzs para GFR2700/GRE2700		
	código	referencia	W0413062
	tope de goma L 40mm An 17mm H 30mm para GFR2700/GRE2700		





código	699570	referencia	W0210414
descripción	tubo para refrigeración diámetro ø 8 L 1700mm GFR2700		
Para modelos:	GFR2700		



código	699572	referencia	W0210418
descripción	tubo para refrigeración diámetro ø 8 L 1700mm GRE2700		
Para modelos:	GRE2700		

empalmes



código	696787	referencia	W0208009
descripción	pieza T cobre int.ø 4.5mm ø ext. 6mm refrigeración para GFR2700		
Para modelos:	GFR2700		
accesorios para	696787		
	código	referencia	W0205011
	válvula magnética tipo FDF2AT empalme 6mm conexión para soldadura L 143mm empalme de tubo ø 6mm 220-240V		
	código	referencia	W0210282
	tubo para refrigeración int.ø 6.5mm L 0.36m refrigeración ø ext. 8mm GFR2700		



tubos calentadoras



código	701583	referencia	C04AC26A0002
descripción	calentador ø ext. 6mm int.ø 3mm L 260mm cobre		
Para modelos:	GPS2600, GSA2600, GSD2600, GSF2600		

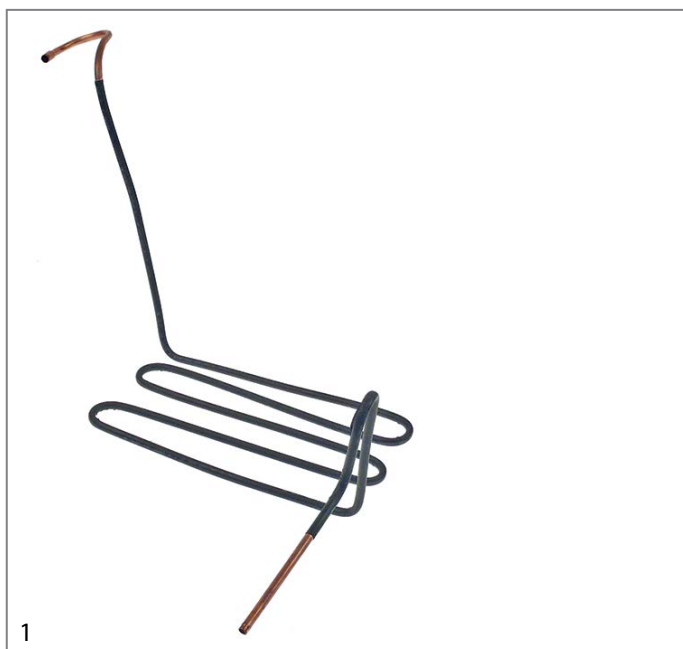

código	701495	referencia	TCGD4010
descripción	calentador ø ext. 6mm int.ø 5mm UE 1m para evaporador ø empalme 6mm		
Para modelos:	GSC1100G		

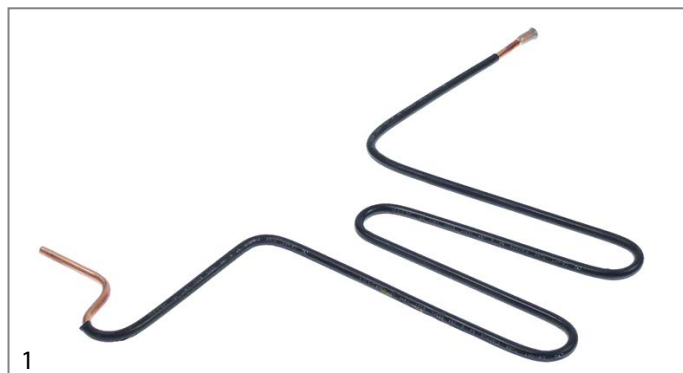



código	701582	referencia	TCGD2001
descripción	calentador tubo ø ext. 5mm int.ø 3mm L 355mm H 250mm		
Para modelos:	GBC1001, GBC1001S, GBC1001SS		

evaporadores para frigoríficos

específico del fabricante



código	750743	referencia	W0202117
descripción	evaporador An 150mm H 135mm L 300mm GRE2700		
Para modelos:	GRE2700		

accesorios para	750743			
	código	699574	referencia	81131204
	cubierta anterior para evaporador L 598mm An 295mm H 65mm para GFR2700/GRE2700			
	código	699577	referencia	80021203
	cubierta izquierdo para evaporador L 255mm An 155mm H 15mm para GFR2700/GRE2700			
	código	699578	referencia	80021204
	cubierta derecho para evaporador L 255mm An 155mm H 15mm para GFR2700/GRE2700			



código	750352	referencia	1.1.A.A10.27
descripción	evaporador L 250mm An 50mm H 117mm		
Para modelos:	GGC1078, GGC1078B		



1

código	750629	referencia	GPC1088-02
descripción	evaporador L 320mm An 320mm H 5mm		
Para modelos:	GPC1088		

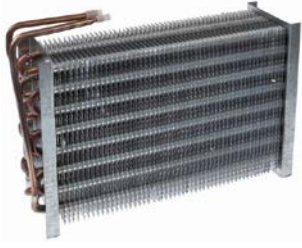

1

código	750350	referencia	1.1.A.A10.40
descripción	evaporador L 345mm An 100mm H 215mm longitud total 345mm anchura total 100mm altura total 240mm para frigorífico		
Para modelos:	GGC2270, GGC2270B		



1

código	750744	referencia	W0202112
descripción	evaporador L 404mm An 175mm H 142mm GFR2700		
Para modelos:	GFR2700		
accesorios para	750744		
	código	699574	referencia 81131204
	cubierta anterior para evaporador L 598mm An 295mm H 65mm para GFR2700/GRE2700		
	código	699577	referencia 80021203
	cubierta izquierdo para evaporador L 255mm An 155mm H 15mm para GFR2700/GRE2700		
	código	699578	referencia 80021204
	cubierta derecho para evaporador L 255mm An 155mm H 15mm para GFR2700/GRE2700		



1

código	750371	referencia	1.1.A.A10.23
descripción	evaporador L 545mm An 50mm H 110mm longitud total 600mm anchura total 50mm altura total 123mm		
Para modelos:	GCV1600		



1

código	750660	referencia	TLZA4003
descripción	evaporador L 620mm An 225mm H 160mm		



1

código	750375	referencia	TLZA4004
descripción	evaporador L 760mm An 140mm H 225mm		



1

código	750387	referencia	TLZA9000
descripción	evaporador para frigorífico GBC1001 L 430mm An 500mm		
Para modelos:	GBC1001, GBC1001S, GBC1001SS		



1

código	750376	referencia	TLZD9001
descripción	evaporador para frigorífico GBC1002 L 760mm An 500mm		
Para modelos:	GBC1002, GBC1002S, GBC1002SS, GBC1102		



1

código	750377	referencia	TLZD9002
descripción	evaporador para frigorífico L 1000mm An 500mm		
Para modelos:	GBC1003, GBC1003S, GBC1003SS, GBC1103		

accesorios

otros



1

código	692868	referencia	W0409079
descripción	cubierta para evaporador plástico GFR2700/GRE2700		
Para modelos:	GFR2700, GRE2700		

condensadores

filtros



1

código	699402	referencia	P04AC28A0002
descripción	filtro para condensador L 218mm An 230mm espesor 6mm UE 1 pzs		
Para modelos:	GDS2600, GPS2600, GSA2600, GSD2600, GSF2600		

condensadores



1

código	750373	referencia	DTLA9002
descripción	condensador An 190mm P 160mm H 205mm UE 1 pzs		
Para modelos:	GBC1003, GBC1003S, GBC1003SS, GBC1103		



1

código	750372	referencia	DTLA9000
descripción	condensador An 195mm P 80mm H 205mm UE 1 pzs		
Para modelos:	GBC1001, GBC1001S, GBC1001SS		

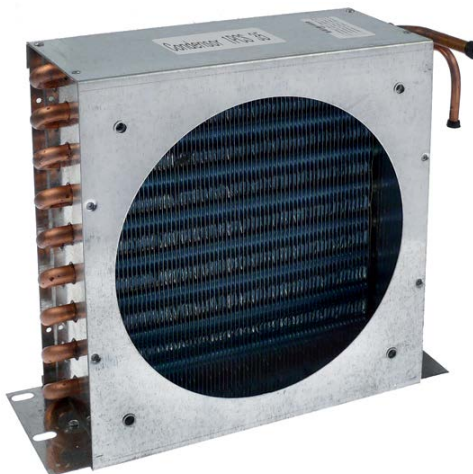

1

código	750347	referencia	C04AC28A0001
descripción	condensador An 220mm P 100mm H 230mm L 270mm		
Para modelos:	GDS2600, GPS2600, GSA2600, GSD2600, GSF2600		



1

código	750384	referencia	1.1.A.A09.01
descripción	condensador An 220mm P 60mm H 280mm UE 1 pzs		
Para modelos:	GGC1078, GGC1078B		

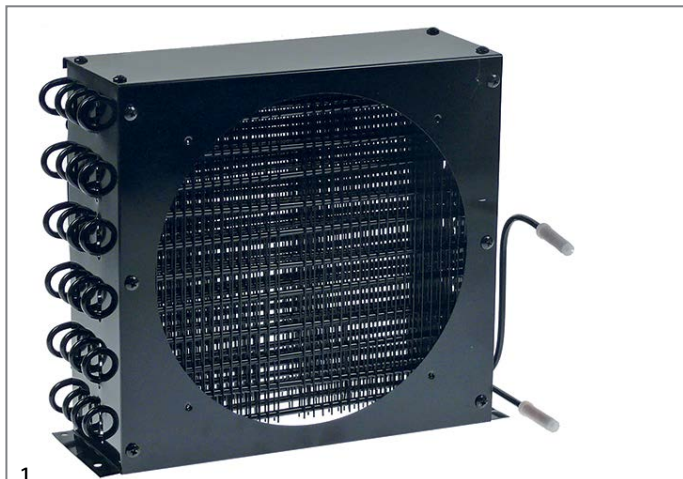

código	750746	referencia	W0203051
descripción	condensador An 250mm H 100mm L 260mm para GRE2700		
Para modelos:	GRE2700		



código	750742	referencia	W0203052
descripción	condensador An 250mm H 140mm L 260mm GFR2700		
Para modelos:	GFR2700		



código	750351	referencia	1.1.A.A09.09
descripción	condensador An 255mm P 130mm H 235mm		
Para modelos:	GGC2270, GGC2270B		

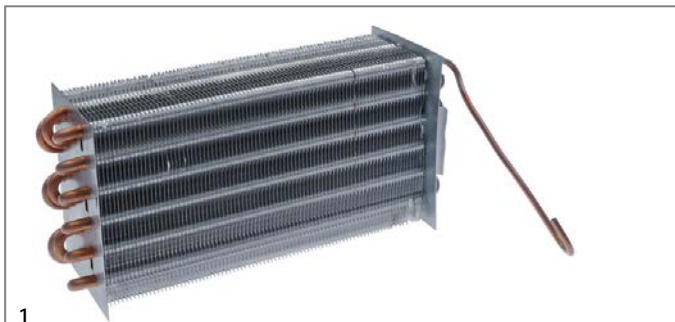

código	750370	referencia	1.1.A.A09.21
descripción	condensador An 265mm P 93mm H 140mm UE 1 pzs		
Para modelos:	GCV1600		



código	750374	referencia	DTLA4008
descripción	condensador An 555mm P 100mm H 275mm UE 1 pzs		

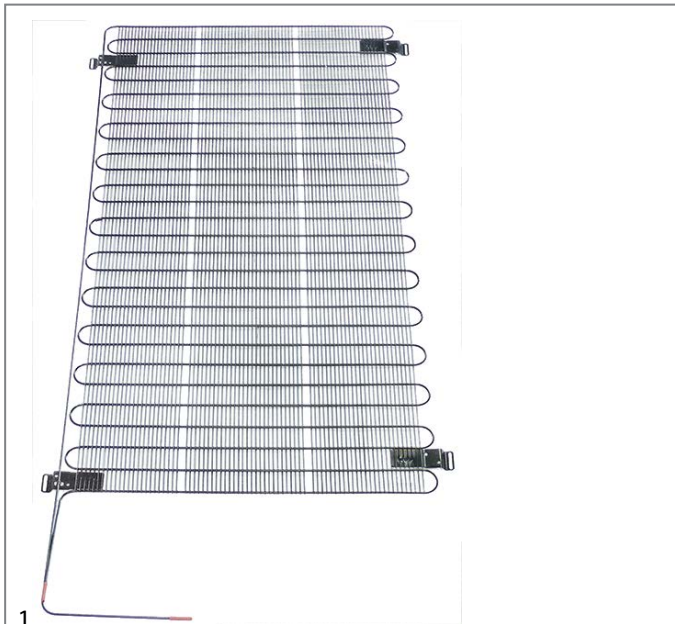

código	750703	referencia	44918000
descripción	condensador An 790mm P 10mm H 1360mm		
Para modelos:	GFR3600S		

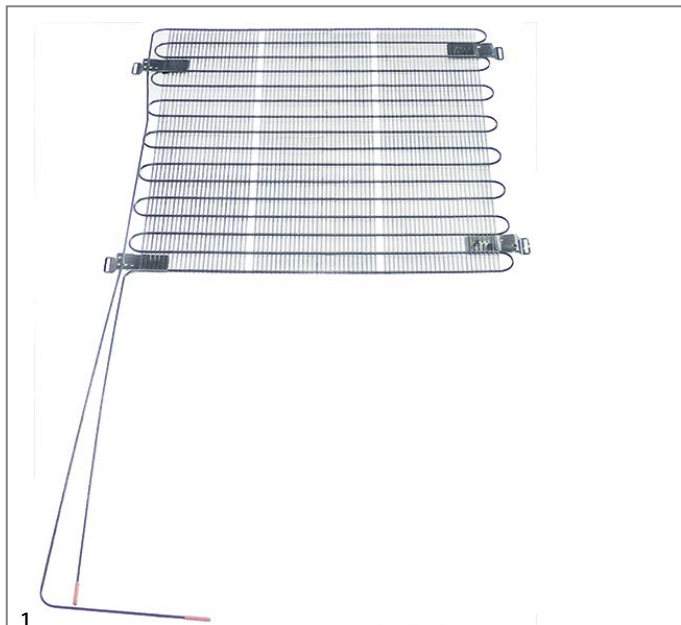

código	750699	referencia	45034000
descripción	condensador An 790mm P 10mm H 750mm UE 1 pzs		
Para modelos:	GRE3600, GRE3600S		



código	750319	referencia	VRX.11
descripción	condensador para mesa pizza An 228mm P 77mm H 179mm		
Para modelos:	GHS1600, GHS2600		

bandejas de agua condensada y cubetas de evaporación

bandejas de agua condensada



código	750745	referencia	W0409071
descripción	bandeja de agua condensada atrás L 527mm An 238mm para frigorífico para GFR2700/GRE2700		
Para modelos:	GFR2700, GRE2700		
accesorios para	750745		

	código	750747	referencia	W0409078
	reboisador plástico para GFR2700/GRE2700			



código	699302	referencia	SLZJ0021
descripción	bandeja de agua condensada L 185mm An 130mm H 75mm		
Para modelos:	GBC1001, GBC1001S, GBC1001SS		



código	699299	referencia	SLZJ0014
descripción	bandeja de agua condensada L 210mm An 105mm H 80mm		
Para modelos:	GSC2336		



código	699211	referencia	I0425088
descripción	bandeja de agua condensada L 230mm An 144mm H 45mm		
Para modelos:	GRE3600, GRE3600S		

cubetas de evaporación sin resistencia



código	750632	referencia	SLZJ0022
descripción	bandeja de goteo L 187mm An 128mm H 70mm plástico		
Para modelos:	GBC1002, GBC1002S, GBC1002SS, GBC1003, GBC1003S, GBC1003SS, GBC1102, GBC1103		



código	750631	referencia	SLZJ0015
descripción	bandeja de goteo L 302mm An 204mm H 85mm plástico		
Para modelos:	GSC1100G		



código	699418	referencia	1.1.C.C29.02
descripción	bandeja de goteo L 400mm An 144mm H 50mm plástico		
Para modelos:	GGC2270, GGC2270B		



1

código	750630	referencia	GPC1088-08
descripción	cubeta de evaporación L 200mm An 135mm H 30mm plástico		
Para modelos:	GPC1088		

otros



1

código	750747	referencia	W0409078
descripción	rebosadero plástico para GFR2700/GRE2700		
Para modelos:	GFR2700, GRE2700		
accesorios para	750747		
	código	referencia	W0409071
	 bandeja de agua condensada atrás L 527mm An 238mm para frigorífico para GFR2700/GRE2700		

técnica de accionamiento y rodamientos de bolas

rodamientos de bolas

cojinetes a bolas 2RS



1

código	523501	referencia	00000000637
descripción	rodamiento de bolas radial tipo 608-2RS árbol \varnothing 8mm \varnothing ext. 22mm An 7mm con arandelas de junta cojinete ranurado DIN 625-1		
Para modelos:	GFS1030		



1

código	523510	referencia	00000000860
descripción	rodamiento de bolas radial tipo 6202-2RS árbol \varnothing 15mm \varnothing ext. 35mm An 11mm con arandelas de junta cojinete ranurado DIN 625-1		
Para modelos:	GFS1025, GFS2019, GFS2022, GFS2025, GFS2030		



1

código	523512	referencia	00000000632
descripción	rodamiento de bolas radial tipo 6204-2RS árbol \varnothing 20mm \varnothing ext. 47mm An 14mm con arandelas de junta cojinete ranurado DIN 625-1		
Para modelos:	GFS1030		



1

código	523504	referencia	00000000862
descripción	rodamiento de bolas radial tipo 626-2RS árbol \varnothing 6mm \varnothing ext. 19mm An 6mm con arandelas de junta cojinete ranurado DIN 625-1		
Para modelos:	GFS1025, GFS2019, GFS2022, GFS2025, GFS2030		

correas de accionamiento

correas trapezoidales nervadas

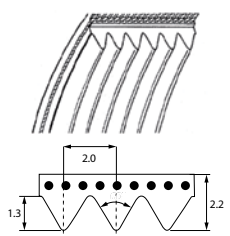
1

código	698215	referencia	00000000635
descripción	correa trapezoidal nervada número de nervios 10 An 20mm L 400mm perfil TB2		
Para modelos:	GFS1030		

1

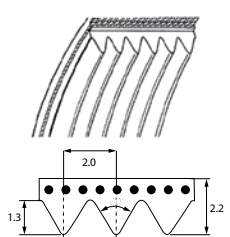
código	698963	referencia	00000000492
descripción	correa trapezoidal nervada número de nervios 5 An 10mm L 310mm perfil TB2		
Para modelos:	GFS2019, GFS2022		



1

código	698217	referencia	00000000861
descripción	correa trapezoidal nervada número de nervios 7 An 14mm L 330mm perfil TB2		
Para modelos:	GFS1025, GFS2025		

muelles

resortes de compresión

1

código	519162	referencia	904131
descripción	resorte		
Para modelos:	GDW2001		

1

código	692701	referencia	1.1.B.B10.06
descripción	resorte L 4mm espesor de hilo 1mm espirales 5 D1 ø 9.5mm		
Para modelos:	GGC1078, GGC1078B		

dosificadores

bombas de membrana

autoaspirantes

SEKO

1

código	362031	referencia	902201
descripción	dosificador tipo DIB E abrillantador caudal 0-5cm ³ por carrera empalme presión ø 4x6mm conector para succión ø 4x6mm conector para succión SEKO presión secundaria cerrado		
Para modelos:	GDW2001		

accesorios

diversos

1

código	513329	referencia	906375
descripción	soporte para dosificadoras L 70mm H 25mm An 40mm acero para muelle		
Para modelos:	GDW2001		

tubos flexibles

tubos de salida

1

código	530921	referencia	907446
descripción	manguera de desagüe 3/4" L 1500mm A ø interno 29mm A ø externo 34mm B ø interno 21mm B ø externo 26mm tubo ø ext. 24mm		
Para modelos:	GDW2001		

1

código	519456	referencia	907439
descripción	manguera de desagüe L 1500mm D1 ø 21mm D2 ø 21mm		
Para modelos:	GDW2001		

tubos flexibles industriales

tubos flexibles de PVC

tubos de PVC sin tejido

1

código	570027	referencia	902046
descripción	tubo flexible de PVC int.ø 4mm ø ext. 7mm L 100m grosor de la pared 1.5mm T máx 60°C transparente		
Para modelos:	GDW2001		

tubos de silicona

sin tejido



1

código	530410	referencia	907279
descripción	tubo de silicona int.ø 4mm ø ext. 7mm L 2m grosor de la pared 1.5mm T máx 200°C transparente		
Para modelos:	GDW2001		

tubos formados

recto



1

código	519392	referencia	903756
descripción	tubo formado L 61mm lavavajillas recto ø tubo 50mm int. ø tubo 38mm		
Para modelos:	GDW2001		

forma L



1

código	503190	referencia	903694
descripción	tubo formado L 120mm entrada EPDM sistemas de lavado 45 ø ext. 56mm		
Para modelos:	GDW2001		



1

código	506280	referencia	909371
descripción	tubo formado L 190mm EPDM sistemas de lavado negro		
Para modelos:	GDW2001		



1

código	505410	referencia	903672
descripción	tubo formado L 70mm sistemas de lavado int.ø 27mm ø ext. 37mm		
Para modelos:	GDW2001		

otros



1

código	699420	referencia	1.1.C.C41.13
descripción	tubo formado int.ø 19mm ø ext. 24mm L 150mm		
Para modelos:	GGC1078, GGC1078B		

para lavavajillas

otros



1

código	503190	referencia	903694
descripción	tubo formado L 120mm entrada EPDM sistemas de lavado 45 ø ext. 56mm		
Para modelos:	GDW2001		



1

código	506280	referencia	909371
descripción	tubo formado L 190mm EPDM sistemas de lavado negro		
Para modelos:	GDW2001		

guarniciones, empalmes para mangueras y tubos

empalmes de tubos

sin racor



1

código	519644	referencia	905434
descripción	pieza T plástico empalme ø12mm - ø5mm - ø12mm		
Para modelos:	GDW2001		



1

código	519216	referencia	905382
descripción	pieza T plástico tubo ø 12-12-12mm 3 vías		
Para modelos:	GDW2001		

material auxiliar

abrazaderas

abrazaderas de alambre doble



1

código	513268	referencia	902425
descripción	abrazadera de tubo ø 8-10mm espesor de hilo 1mm UE 1 pzs		
Para modelos:	GDW2001		

material de sujeción

tornillos

tornillos planos



1

código	560551	referencia	0000000615
descripción	tornillo plano rosca M10 L 15mm Inox UE 1 pzs soporte ranura ø cabezal 24.5mm		
Para modelos:	GFS1030		

tornillos de cabeza moleteada



1

código	697481	referencia	0000000623
descripción	tornillo de cabeza moleteada rosca M6 rosca L 8mm ø 14mm H 6mm inox		
Para modelos:	GFS1030, GFS2019, GFS2022, GFS2025		

tuercas

tuercas hexagonales

DIN 985



1

código	560142	referencia	902040
descripción	tuerca hexagonal rosca M6 H 6mm inox EC 10 UE 20 pzs DIN/ISO DIN 985 autobloqueo		
Para modelos:	GDW2001		

otros



1

código	551380	referencia	DAD30010
descripción	tuerca enjaulada rosca M10 UE 4 pzs		
Para modelos:	GCO500		

arandelas

arandelas elásticas



1

código	697478	referencia	0000000671
descripción	arandela de muelle int.ø 19mm ø ext. 26mm UE 1 pzs		
Para modelos:	GFS1030		

arandelas

otros



1

código	519238	referencia	906002
descripción	arandela int.ø 15mm ø ext. 33mm espesor 0.8mm inox UE 1 pzs		
Para modelos:	GDW2001		

sujeciones

clips de fijación

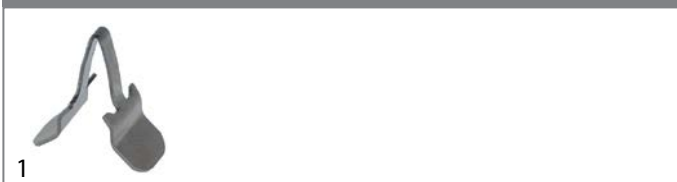

código	692865	referencia	00007750
descripción	clip de sujeción para portalámparas L 16mm H 19mm		
Para modelos:	GCO2001		

abrazaderas

abrazaderas de alambre doble



código	513268	referencia	902425
descripción	abrazadera de tubo ø 8-10mm espesor de hilo 1mm UE 1 pzs		
Para modelos:	GDW2001		

pasadores elásticos



código	691637	referencia	0744
descripción	pasador elástico ø 3mm L 20mm		
Para modelos:	GSM1000		

A			
abrazaderas	91, 92		
abrazaderas de alambre doble	91, 92		
accesorios eléctricos	33		
accesorios para lámparas	15		
anillos de junta	79		
arandelas	91		
arandelas elásticas	91		
B			
balastros	13		
bisagras para hornos	67		
bobinas de inducción	3		
bombas	32		
bombas de aumento de presión II	32		
bombas de lavado y aclarado	32		
bombas de salida	32		
C			
cables	33		
cables de alimentación aparatos	33		
cables de calefacción	4		
cables de enlace	35		
cajas de bornes	35		
cebadores	13		
clips de fijación	92		
compensadores de tracción	34		
componentes para el circuito frigorífico	80		
compresores	23		
condensadores de alta tensión	33		
condensadores de servicio	32		
condensadores y filtros antiparasitarios	32		
conmutadores de levas	10		
contactores	16		
controladores electrónicos	17		
D			
dosificadores	89		
E			
empalmes de tubos	91		
evaporadores	83		
F			
filtros	33		
filtros deshidratadores antiácidos	80		
fusibles	33		
I			
interruptores de sistema ROLD	9		
interruptores magnéticos	10		
interruptores posicionales	9		
		interruptores pulsantes y pulsadores	8
		interruptores y pulsadores	8
		interruptores/pulsadores basculantes	8
J			
		juntas de árbol	79
		juntas insertables	77
		juntas para frigoríficos	77
		juntas para puertas	78
		juntas patra brazos de lavado	79
		juntas roscadas	77
		juntas térmicas	78
		juntas tóricas	78
L			
		lámparas	10
		lámparas de señalización	10
		lámparas de señalización completas	11
		lámparas fluorescentes	13, 13
		lámparas para hornos	14
		lámparas para microondas	14
		LEDs	12
M			
		magnetrones	16
		material de sujeción	91
		microinterruptores	8
		motores	31
		motores refrigeración universales	26
P			
		parrillas	73
		pasacables	34
		pasadores elásticos	92
		presostatos	23
R			
		racores para cables	34
		reguladores de revoluciones	30
		rejillas y rieles guía	73
		relés	16
		resistencias	3
		resistencias circulación de aire	5
		resistencias de cuarzo	4
		resistencias de inmersión	4
		resistencias para freidora	3
		resistencias para hornos	3
		resistencias para plancha grills	3
		resistencias planas	5
		ruedas para aparatos y esquinas protectoras	72
S			
		semiconductores de potencia	16

señalizadores de alarma	15
sensores	19
sensores universales	19
sondas de temperatura	19
sujeciones	92

T

temporizador de descongelación	15
temporizadores	15
temporizadores mecánicos	15
terminales	35
termostatos	5
termostatos de regulación	6, 7
termostatos de seguridad	6
termostatos de superficie	5, 6
termostatos de superficie de seguridad	5
termostatos para frío	7
tornillos	91
tornillos de cabeza moleteada	91
tornillos planos	91
transformadores	16
tubos de cobre aislados	82
tubos de cobre sin aislar	80
tubos de salida	89
tubos de silicona	90
tubos flexibles	89
tubos flexibles de PVC	89
tubos flexibles industriales	89
tubos formados	90
tubos para refrigeración	80
tuercas	91
tuercas hexagonales	91

V

válvulas magnéticas	22
válvulas Schrader	80
ventilador axial	25
ventiladores	25
ventiladores de aire caliente	29
ventiladores de refrigeración	28
ventiladores para frigoríficos	26
ventiladores tangenciales	29